

Legend

-  PUMP HOUSE
-  MDT
-  MT
-  Rising Main
-  Gravity Main
-  GUIN_1
-  GUIN_2
-  DARUMANN
-  CHEH
-  CHATTER
-  PEHAD-2
-  HIUN
-  DEDHAL
-  Banerti_2
-  KUMARHDA-1
-  KUMARHDA-2
-  TRAMABLA
-  SIRAM
-  GALL00
-  TAUR_JAJAR

SIGN. OF CLIENT:-

JE	AE	EE	SE
----	----	----	----



**DETAILED DESIGN CONSULTANCY, HP-SHIVA
(PACKAGE CS09)**

IRRIGATION, HORTICULTURE, ORCHARDS AND VALUE CHAIN DEVELOPMENT

SIGN.												
	INITIALS											
REVISIONS												
	INITIALS											
P0	GKJ	ES	MK					MK	DK	27-04-2022		
	REVISIONS											
ISSUE	DRN	DSN	CHD	CV	EL	IC	ME			PE/PM	APPD.	DATE
	CLEARED											

'P' (PRELIMINARY) ISSUES ARE NOT TO BE USED FOR CONSTRUCTION / FABRICATION BUT ARE ISSUED FOR LIMITED PURPOSES ONLY AS INDICATED IN THE SMALL BLOCK ABOVE THIS BLOCK.

CONSTRUCTION / FABRICATION WORK IS PERMITTED ON 'R' (RELEASED) ISSUES ONLY.

INFORMATION CONTAINED WITHIN 'HOLD' IS NOT RELEASED FOR CONSTRUCTION / FABRICATION. FIELD MUST GET DESIGN OFFICE TO CLEAR 'HOLDS' IN TIME BEFORE PROCEEDING WITH ANY CONSTRUCTION/FABRICATION WORK RELATED TO 'HOLDS'.

PURPOSE: FOR TENDER ONLY

Proprietary Notice and Version Control This document contains confidential information for use only by the "Client"; for the Project under consideration, which is provided for the sole purpose of permitting the recipient to evaluate the information submitted here with in consideration of receipt of this document; unless agreed to in contrary in the Contract; the recipient agrees to maintain such information in confidence and to not reproduce or otherwise disclose this information to any person outside the recipient's organisation; except that there is no obligation to maintain the confidentiality of any information which was known to the recipient prior to receipt of such information from Tata Consulting Engineers Limited, or becomes publicly known through no fault of recipient, or Tata Consulting Engineers Limited, or is received without obligation of confidentiality from a third party owing no obligation of confidentiality to Tata Consulting Engineers Limited. All information given under this version over rides all and any kind of offers, assumptions, deliverables and contracts submitted verbally (and subsequently communicated in writing) or in writing or otherwise given under any and all previous version/s.

File Name:12503A-CV-32117-Rev-P0







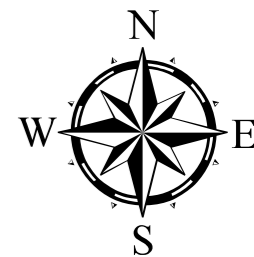
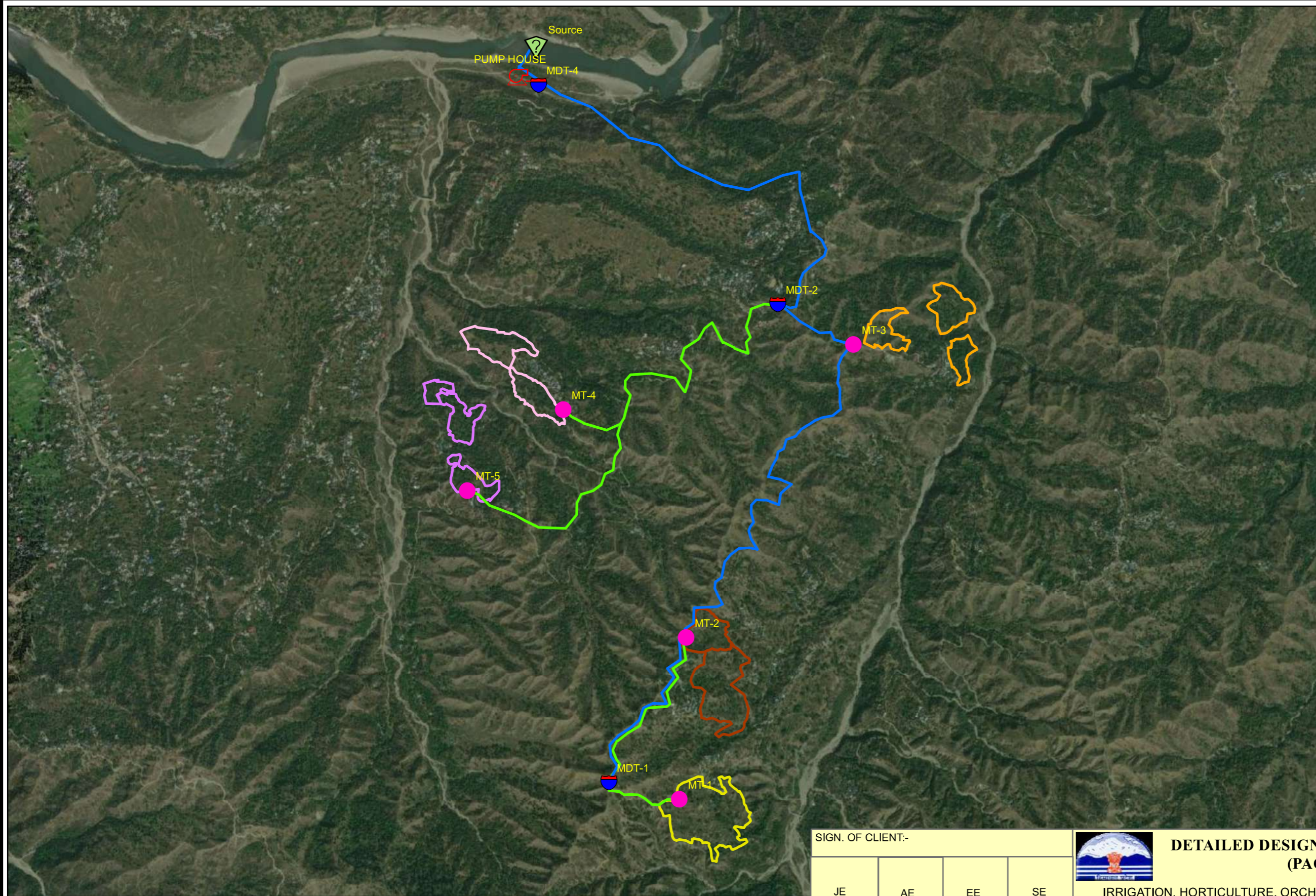





**TATACONSULTING ENGINEERS LIMITED.
MUMBAI**

SCALE:- 1:55,000	DWG. No:- TCE.12503A-CV-3005-LM-32117	ISSUE:- P0
DL.CEN:- DEL-CV		



Legend

-  Source
-  PUMP HOUSE
-  MDT
-  MT
-  Rising Main
-  Gravity Main
-  LOWER_BALH
-  CHATRAUN_LOWER
-  DHALARA-1
-  DHALARA-2
-  BHAN

SIGN. OF CLIENT:-

JE	AE	EE	SE
----	----	----	----



**DETAILED DESIGN CONSULTANCY, HP-SHIVA
(PACKAGE CS09)**

IRRIGATION, HORTICULTURE, ORCHARDS AND VALUE CHAIN DEVELOPMENT

PURPOSE: FOR TENDER ONLY

TITLE:- **KEY PLAN OF LIS KOTHUA DALLARA
(DHALARA-1 & 2, LOWER BALH, CHATRAUN LOWER, BHAN)
DHARAMPUR BLOCK, MANDI DISTRICT.**



**TATACONSULTING ENGINEERS LIMITED.
MUMBAI**

SIGN.												
	INITIALS											
REVISIONS												
SIGN.												
	INITIALS	GKJ	ES	DVB			MK	DK	13-06-2022			
REVISIONS												
ISSUE	DRN	DSN	CHD	CV	EL	IC	ME			PE/PM	APPD.	DATE
	CLEARED											

'P' (PRELIMINARY) ISSUES ARE NOT TO BE USED FOR CONSTRUCTION / FABRICATION BUT ARE ISSUED FOR LIMITED PURPOSES ONLY AS INDICATED IN THE SMALL BLOCK ABOVE THIS BLOCK.

CONSTRUCTION / FABRICATION WORK IS PERMITTED ON 'R' (RELEASED) ISSUES ONLY.

INFORMATION CONTAINED WITHIN 'HOLD' IS NOT RELEASED FOR CONSTRUCTION / FABRICATION. FIELD MUST GET DESIGN OFFICE TO CLEAR 'HOLDS' IN TIME BEFORE PROCEEDING WITH ANY CONSTRUCTION/FABRICATION WORK RELATED TO 'HOLDS'.

Proprietary Notice and Version Control This document contains confidential information for use only by the "Client"; for the Project under consideration, which is provided for the sole purpose of permitting the recipient to evaluate the information submitted here with in consideration of receipt of this document; unless agreed to in contrary in the Contract, the recipient agrees to maintain such information in confidence and to not reproduce or otherwise disclose this information to any person outside the recipient's organisation; except that there is no obligation to maintain the confidentiality of any information which was known to the recipient prior to receipt of such information from Tata Consulting Engineers Limited, or becomes publicly known through no fault of recipient, or Tata Consulting Engineers Limited, or is received without obligation of confidentiality from a third party owing no obligation of confidentiality to Tata Consulting Engineers Limited. All information given under this version over rides all and any kind of offers, assumptions, deliverables and contracts submitted verbally (and subsequently communicated in writing) or in writing or otherwise given under any and all previous version/s.

File Name:12503A-CV-32118-Rev-P0

SCALE:- 1:20,000	DWG. No:-	ISSUE:-
DL.CEN:- DEL-CV	TCE.12503A-CV-3005-LM-32118	P0

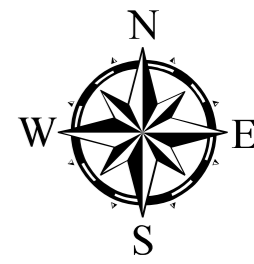
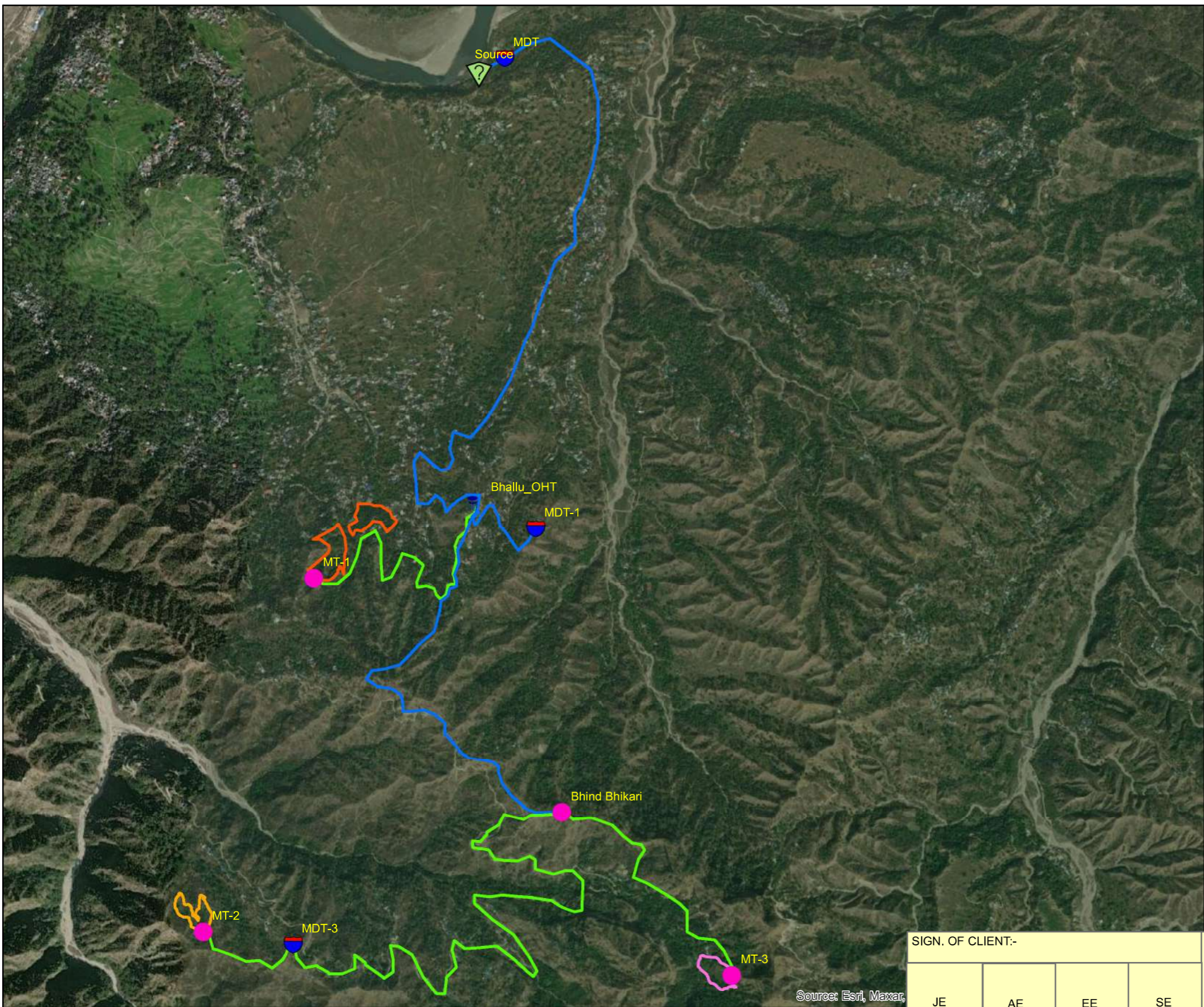

Legend

- Source
- MDT
- MT
- Rising Main
- Gravity Main
- LAHSANI
- KANOHI
- SINGLE KUHAT

Source: Esri, Maxar

SIGN. OF CLIENT:-			
JE	AE	EE	SE

	DETAILED DESIGN CONSULTANCY, HP-SHIVA (PACKAGE CS09)
	IRRIGATION, HORTICULTURE, ORCHARDS AND VALUE CHAIN DEVELOPMENT

SIGN.											
	INITIALS										
	REVISIONS										
P0	SIGN.										
	INITIALS	GKJ	ES	DVB			MK	DK	13-06-2022		
	REVISIONS										
ISSUE	DRN	DSN	CHD	CV	EL	IC	ME		PE/PM	APPD.	DATE
	CLEARED										

'P' (PRELIMINARY) ISSUES ARE NOT TO BE USED FOR CONSTRUCTION / FABRICATION BUT ARE ISSUED FOR LIMITED PURPOSES ONLY AS INDICATED IN THE SMALL BLOCK ABOVE THIS BLOCK.

CONSTRUCTION / FABRICATION WORK IS PERMITTED ON 'R' (RELEASED) ISSUES ONLY.

INFORMATION CONTAINED WITHIN 'HOLD' IS NOT RELEASED FOR CONSTRUCTION / FABRICATION. FIELD MUST GET DESIGN OFFICE TO CLEAR 'HOLDS' IN TIME BEFORE PROCEEDING WITH ANY CONSTRUCTION/FABRICATION WORK RELATED TO 'HOLDS'.

PURPOSE: FOR TENDER ONLY

Proprietary Notice and Version Control This document contains confidential information for use only by the "Client"; for the Project under consideration, which is provided for the sole purpose of permitting the recipient to evaluate the information submitted here with in consideration of receipt of this document; unless agreed to in contrary in the Contract, the recipient agrees to maintain such information in confidence and to not reproduce or otherwise disclose this information to any person outside the recipient's organisation; except that there is no obligation to maintain the confidentiality of any information which was known to the recipient prior to receipt of such information from Tata Consulting Engineers Limited, or becomes publicly known through no fault of recipient, or Tata Consulting Engineers Limited, or is received without obligation of confidentiality from a third party owing no obligation of confidentiality to Tata Consulting Engineers Limited. All information given under this version over rides all and any kind of offers, assumptions, deliverables and contracts submitted verbally (and subsequently communicated in writing) or in writing or otherwise given under any and all previous version/s.





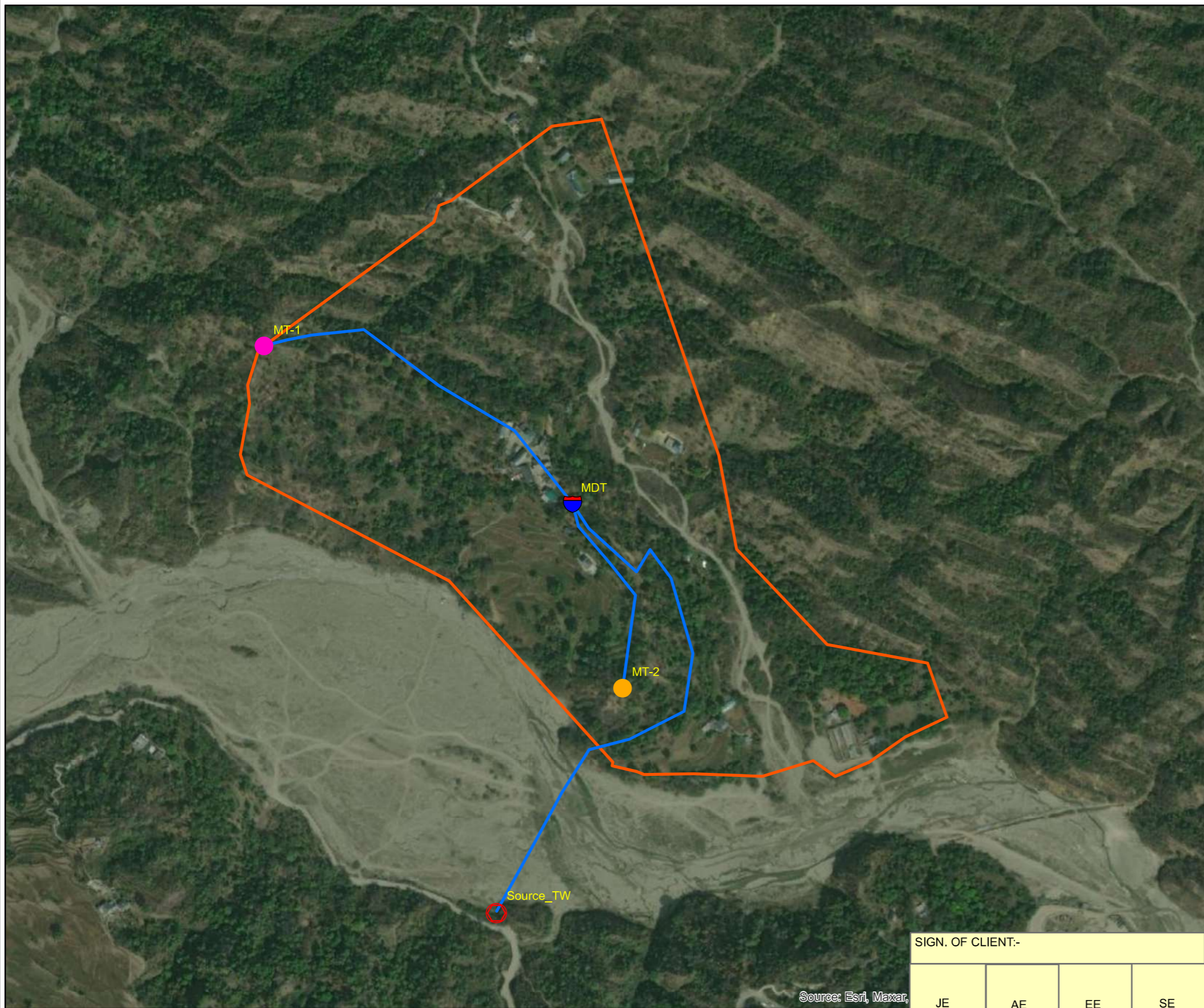
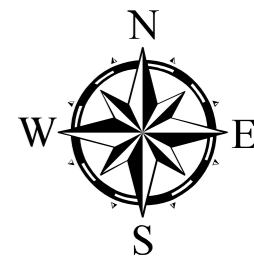

File Name:12503A-CV-32119-Rev-P0

	TATACONSULTING ENGINEERS LIMITED. MUMBAI	
	SCALE:- 1:22,000	DWG. No:- TCE.12503A-CV-3005-LM-32119
DL.CEN.:- DEL-CV		ISSUE:- P0



Source: Esri, Maxar,

Legend

-  Source_TW
-  MDT
-  MT-1
-  MT-2
-  Rising Main
-  CHURUBALA

SIGN. OF CLIENT:-

JE	AE	EE	SE
----	----	----	----



DETAILED DESIGN CONSULTANCY, HP-SHIVA (PACKAGE CS09)

IRRIGATION, HORTICULTURE, ORCHARDS AND VALUE CHAIN DEVELOPMENT

PURPOSE: FOR TENDER ONLY

TITLE:-
KEY PLAN OF LIS CHURU RA BALH
DHARAMPUR BLOCK, MANDI DISTRICT.



TATACONSULTING ENGINEERS LIMITED. MUMBAI

SIGN.												
	INITIALS											
REVISIONS												
P0	SIGN.											
	INITIALS	GKJ	ES	DVB			MK	DK	13-06-2022			
REVISIONS												
ISSUE	DRN	DSN	CHD	CV	EL	IC	ME			PE/PM	APPD.	DATE
				CLEARED								

'P' (PRELIMINARY) ISSUES ARE NOT TO BE USED FOR CONSTRUCTION / FABRICATION BUT ARE ISSUED FOR LIMITED PURPOSES ONLY AS INDICATED IN THE SMALL BLOCK ABOVE THIS BLOCK.

CONSTRUCTION / FABRICATION WORK IS PERMITTED ON 'R' (RELEASED) ISSUES ONLY.

INFORMATION CONTAINED WITHIN 'HOLD' IS NOT RELEASED FOR CONSTRUCTION / FABRICATION. FIELD MUST GET DESIGN OFFICE TO CLEAR 'HOLDS' IN TIME BEFORE PROCEEDING WITH ANY CONSTRUCTION/FABRICATION WORK RELATED TO 'HOLDS'.





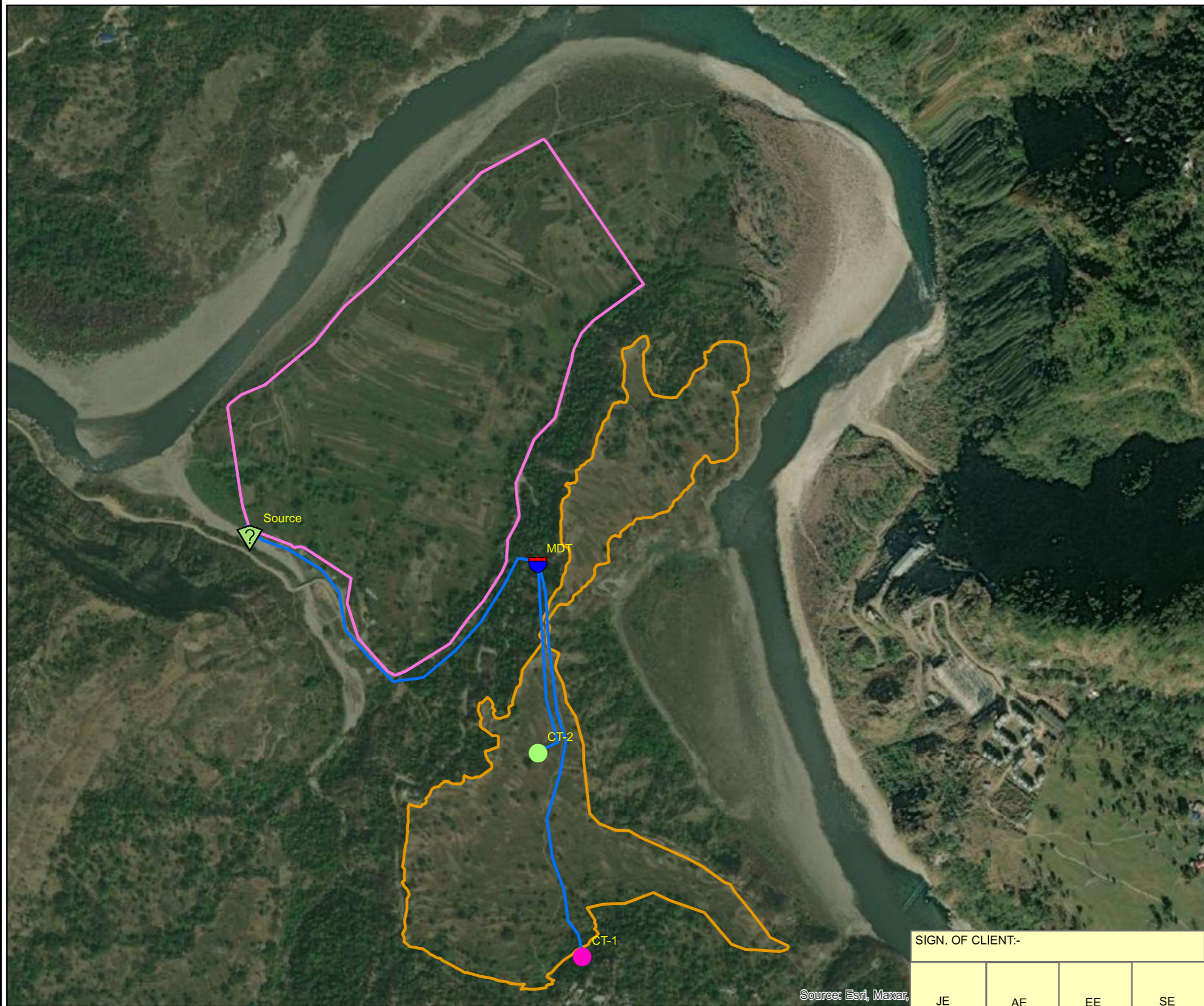
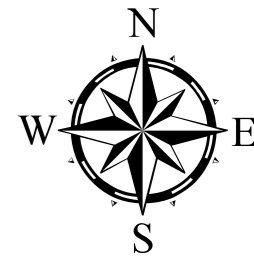

Proprietary Notice and Version Control This document contains confidential information for use only by the "Client"; for the Project under consideration, which is provided for the sole purpose of permitting the recipient to evaluate the information submitted here with. In consideration of receipt of this document; unless agreed to in contrary in the Contract; the recipient agrees to maintain such information in confidence and to not reproduce or otherwise disclose this information to any person outside the recipient's organisation; except that there is no obligation to maintain the confidentiality of any information which was known to the recipient prior to receipt of such information from Tata Consulting Engineers Limited, or becomes publicly known through no fault of recipient, or Tata Consulting Engineers Limited, or is received without obligation of confidentiality from a third party owing no obligation of confidentiality to Tata Consulting Engineers Limited. All information given under this version over rides all and any kind of offers, assumptions, deliverables and contracts submitted verbally (and subsequently communicated in writing) or in writing or otherwise given under any and all previous version/s.

File Name: 12503A-CV-32120-Rev-P0

SCALE:- 1:5,000	DWG. No:-	ISSUE:-
DL.CEN:- DEL-CV	TCE.12503A-CV-3005-LM-32120	P0



Legend

-  Source
-  MDT
-  CT-1
-  CT-2
-  Rising Main
-  SEOHBALL
-  SEOH

SIGN. OF CLIENT:-

JE	AE	EE	SE
----	----	----	----



DETAILED DESIGN CONSULTANCY, HP-SHIVA (PACKAGE CS09)

IRRIGATION, HORTICULTURE, ORCHARDS AND VALUE CHAIN DEVELOPMENT

SIGN.											
	INITIALS										
	REVISIONS										
P0	SIGN.										
	INITIALS	GKJ	ES	DVB			MK	DK	13-06-2022		
	REVISIONS										
ISSUE	DRN	DSN	CHD	CV	EL	IC	ME		PE/PM	APPD.	DATE
	CLEARED										

'P' (PRELIMINARY) ISSUES ARE NOT TO BE USED FOR CONSTRUCTION / FABRICATION BUT ARE ISSUED FOR LIMITED PURPOSES ONLY AS INDICATED IN THE SMALL BLOCK ABOVE THIS BLOCK.

CONSTRUCTION / FABRICATION WORK IS PERMITTED ON 'R' (RELEASED) ISSUES ONLY.

INFORMATION CONTAINED WITHIN 'HOLD' IS NOT RELEASED FOR CONSTRUCTION / FABRICATION. FIELD MUST GET DESIGN OFFICE TO CLEAR 'HOLDS' IN TIME BEFORE PROCEEDING WITH ANY CONSTRUCTION/FABRICATION WORK RELATED TO 'HOLDS'.

PURPOSE: FOR TENDER ONLY

Proprietary Notice and Version Control This document contains confidential information for use only by the "Client"; for the Project under consideration, which is provided for the sole purpose of permitting the recipient to evaluate the information submitted here with in consideration of receipt of this document; unless agreed to in contrary in the Contract, the recipient agrees to maintain such information in confidence and to not reproduce or otherwise disclose this information to any person outside the recipient's organisation; except that there is no obligation to maintain the confidentiality of any information which was known to the recipient prior to receipt of such information from Tata Consulting Engineers Limited, or becomes publicly known through no fault of recipient, or Tata Consulting Engineers Limited, or is received without obligation of confidentiality from a third party owing no obligation of confidentiality to Tata Consulting Engineers Limited. All information given under this version over rides all and any kind of offers, assumptions, deliverables and contracts submitted verbally (and subsequently communicated in writing) or in writing or otherwise given under any and all previous version/s.

File Name:12503A-CV-32121-Rev-P0

TITLE:-
KEY PLAN OF LIS SEOH (SEOH-II, SEOH (BALH) NICHLA ROPA) DHARAMPUR BLOCK, MANDI DISTRICT.







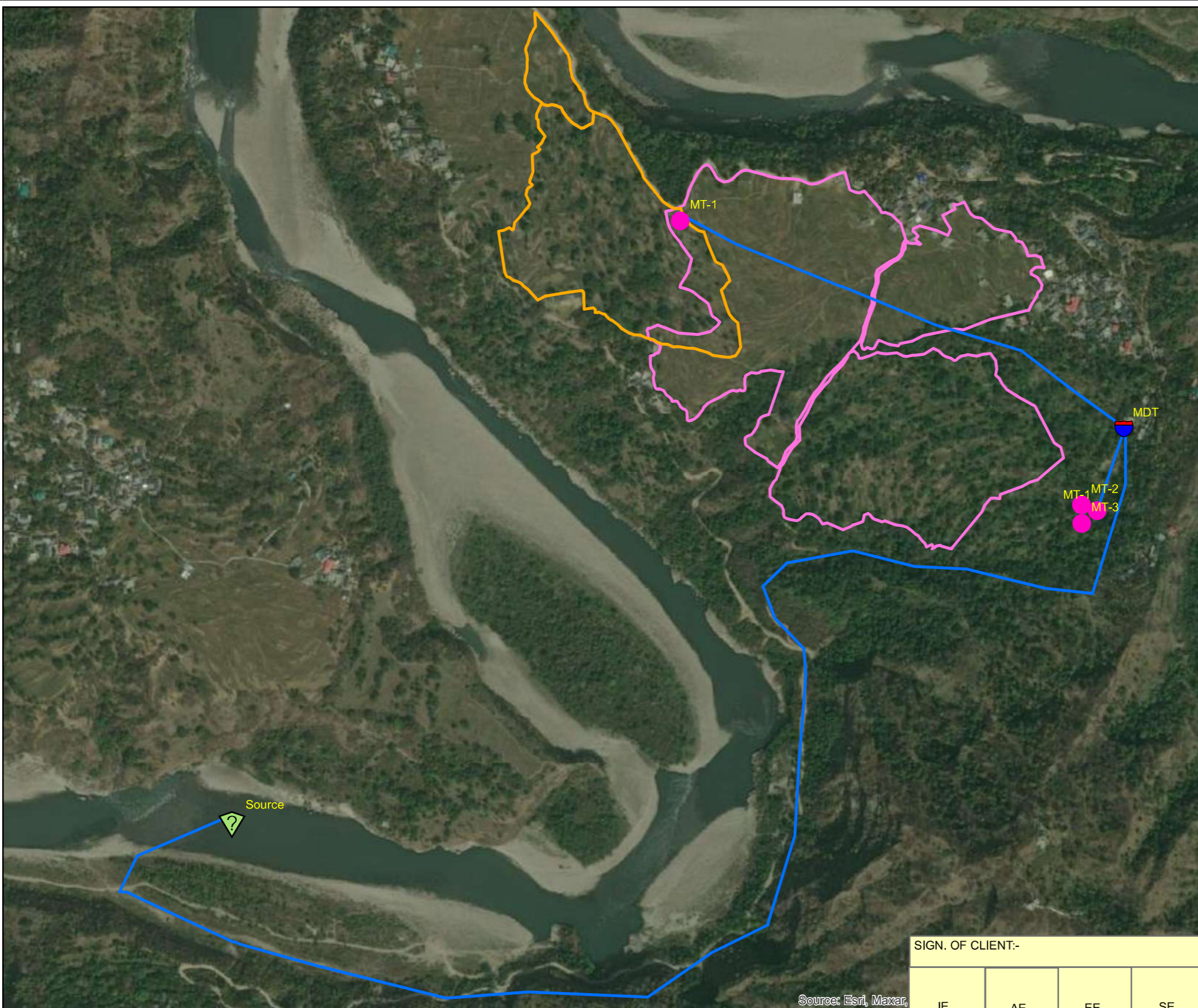
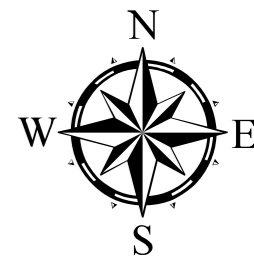

TATACONSULTING ENGINEERS LIMITED. MUMBAI

SCALE:- 1:8,000	DWG. No:- TCE.12503A-CV-3005-LM-32121	ISSUE:- P0
DL.CEN.:- DEL-CV		



Legend

-  Source
-  MDT
-  MT
-  Rising Main
-  NICHLI_BERI
-  UPPERBERI

Source: Esri, Maxar

SIGN. OF CLIENT:-

JE	AE	EE	SE
----	----	----	----



DETAILED DESIGN CONSULTANCY, HP-SHIVA (PACKAGE CS09)

IRRIGATION, HORTICULTURE, ORCHARDS AND VALUE CHAIN DEVELOPMENT

PURPOSE: FOR TENDER ONLY

TITLE:-
KEY PLAN OF LIS BAIRI (LOWER (NICHALI) BAIRI, UPPER BAIRI) DHARAMPUR BLOCK, MANDI DISTRICT.

SIGN.												
	INITIALS											
REVISIONS												
SIGN.												
	INITIALS	GKJ	ES	DVB			MK	DK	13-06-2022			
REVISIONS												
ISSUE	DRN	DSN	CHD	CV	EL	IC	ME			PE/PM	APPD.	DATE
	CLEARED											

'P' (PRELIMINARY) ISSUES ARE NOT TO BE USED FOR CONSTRUCTION / FABRICATION BUT ARE ISSUED FOR LIMITED PURPOSES ONLY AS INDICATED IN THE SMALL BLOCK ABOVE THIS BLOCK.

CONSTRUCTION / FABRICATION WORK IS PERMITTED ON 'R' (RELEASED) ISSUES ONLY.

INFORMATION CONTAINED WITHIN 'HOLD' IS NOT RELEASED FOR CONSTRUCTION / FABRICATION. FIELD MUST GET DESIGN OFFICE TO CLEAR 'HOLDS' IN TIME BEFORE PROCEEDING WITH ANY CONSTRUCTION/FABRICATION WORK RELATED TO 'HOLDS'.

Proprietary Notice and Version Control This document contains confidential information for use only by the "Client"; for the Project under consideration, which is provided for the sole purpose of permitting the recipient to evaluate the information submitted here with. In consideration of receipt of this document; unless agreed to in contrary in the Contract; the recipient agrees to maintain such information in confidence and to not reproduce or otherwise disclose this information to any person outside the recipient's organisation; except that there is no obligation to maintain the confidentiality of any information which was known to the recipient prior to receipt of such information from Tata Consulting Engineers Limited, or becomes publicly known through no fault of recipient, or Tata Consulting Engineers Limited, or is received without obligation of confidentiality from a third party owing no obligation of confidentiality to Tata Consulting Engineers Limited. All information given under this version over rides all and any kind of offers, assumptions, deliverables and contracts submitted verbally (and subsequently communicated in writing) or in writing or otherwise given under any and all previous version/s.

File Name: 12503A-CV-32122-Rev-P0





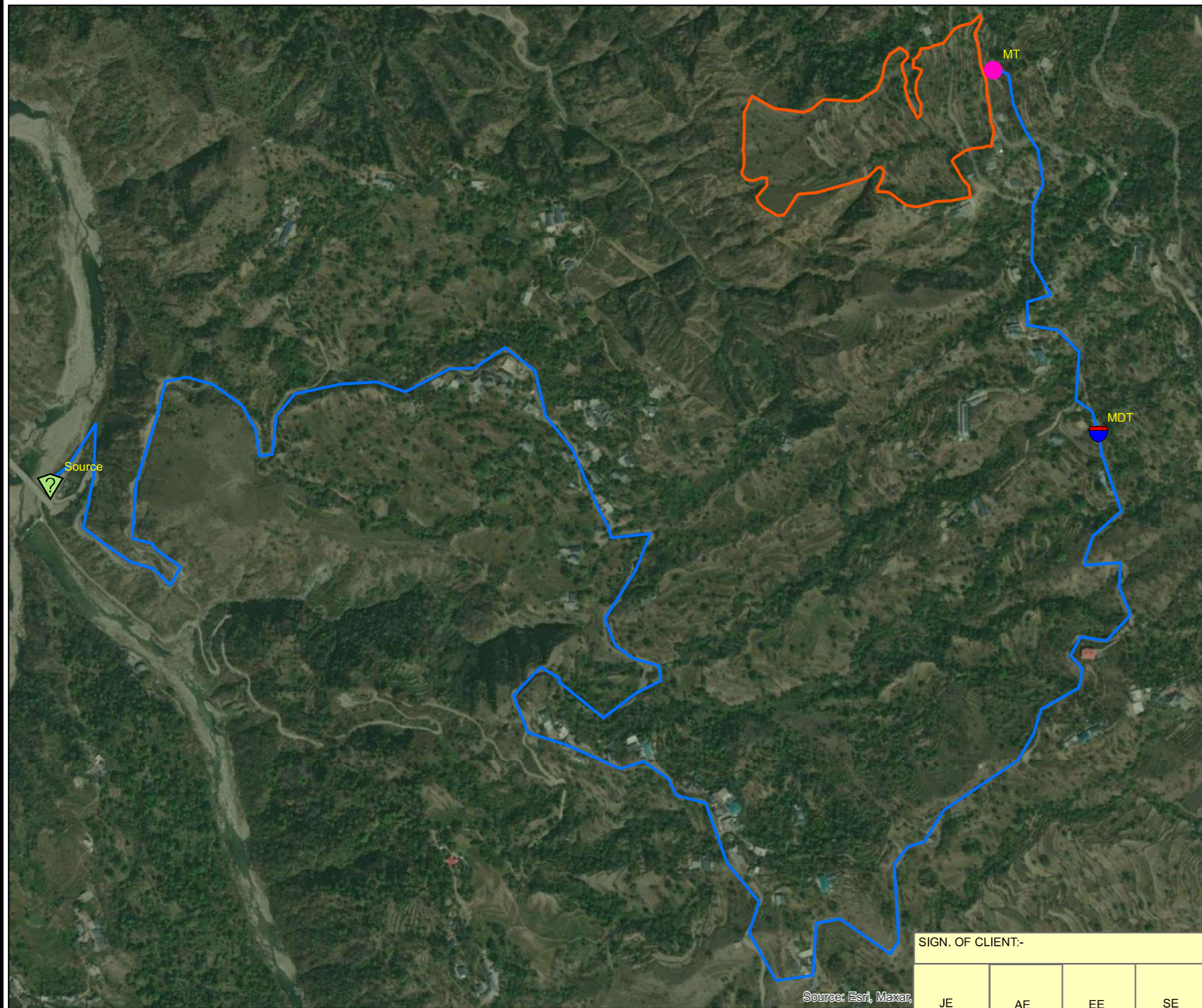
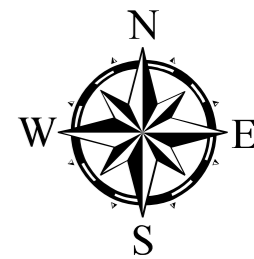

TATACONSULTING ENGINEERS LIMITED. MUMBAI

SCALE:- 1:8,000	DWG. No:- TCE.12503A-CV-3005-LM-32122	ISSUE:- P0
DL.CEN:- DEL-CV		



Legend

-  Source
-  MDT
-  MT
-  Rising Main
-  BAROTA

Source: Esri, Maxar,

SIGN. OF CLIENT:-

JE	AE	EE	SE
----	----	----	----



DETAILED DESIGN CONSULTANCY, HP-SHIVA (PACKAGE CS09)

IRRIGATION, HORTICULTURE, ORCHARDS AND VALUE CHAIN DEVELOPMENT

PURPOSE: FOR TENDER ONLY

TITLE:-
KEY PLAN OF LIS BRANG (BAROTA CLUSTER)
 DHARAMPUR BLOCK, MANDI DISTRICT.



TATACONSULTING ENGINEERS LIMITED. MUMBAI

SIGN.												
	INITIALS											
REVISIONS												
P0	SIGN.											
	INITIALS	GKJ	ES	DVB			MK	DK	13-06-2022			
REVISIONS												
ISSUE	DRN	DSN	CHD	CV	EL	IC	ME			PE/PM	APPD.	DATE
					CLEARED							

'P' (PRELIMINARY) ISSUES ARE NOT TO BE USED FOR CONSTRUCTION / FABRICATION BUT ARE ISSUED FOR LIMITED PURPOSES ONLY AS INDICATED IN THE SMALL BLOCK ABOVE THIS BLOCK.

CONSTRUCTION / FABRICATION WORK IS PERMITTED ON 'R' (RELEASED) ISSUES ONLY.

INFORMATION CONTAINED WITHIN 'HOLD' IS NOT RELEASED FOR CONSTRUCTION / FABRICATION. FIELD MUST GET DESIGN OFFICE TO CLEAR 'HOLDS' IN TIME BEFORE PROCEEDING WITH ANY CONSTRUCTION/FABRICATION WORK RELATED TO 'HOLDS'.

Proprietary Notice and Version Control This document contains confidential information for use only by the "Client"; for the Project under consideration, which is provided for the sole purpose of permitting the recipient to evaluate the information submitted here with. In consideration of receipt of this document; unless agreed to in contrary in the Contract; the recipient agrees to maintain such information in confidence and to not reproduce or otherwise disclose this information to any person outside the recipient's organisation; except that there is no obligation to maintain the confidentiality of any information which was known to the recipient prior to receipt of such information from Tata Consulting Engineers Limited, or becomes publicly known through no fault of recipient, or Tata Consulting Engineers Limited, or is received without obligation of confidentiality from a third party owing no obligation of confidentiality to Tata Consulting Engineers Limited. All information given under this version over rides all and any kind of offers, assumptions, deliverables and contracts submitted verbally (and subsequently communicated in writing) or in writing or otherwise given under any and all previous version/s.

File Name:12503A-CV-32123-Rev-P0

SCALE:- 1:6,500	DWG. No:-	ISSUE:-
DL.CEN:- DEL-CV	TCE.12503A-CV-3005-LM-32123	P0

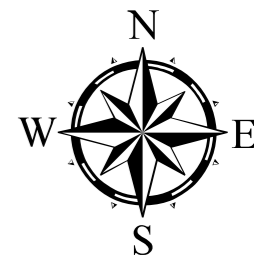
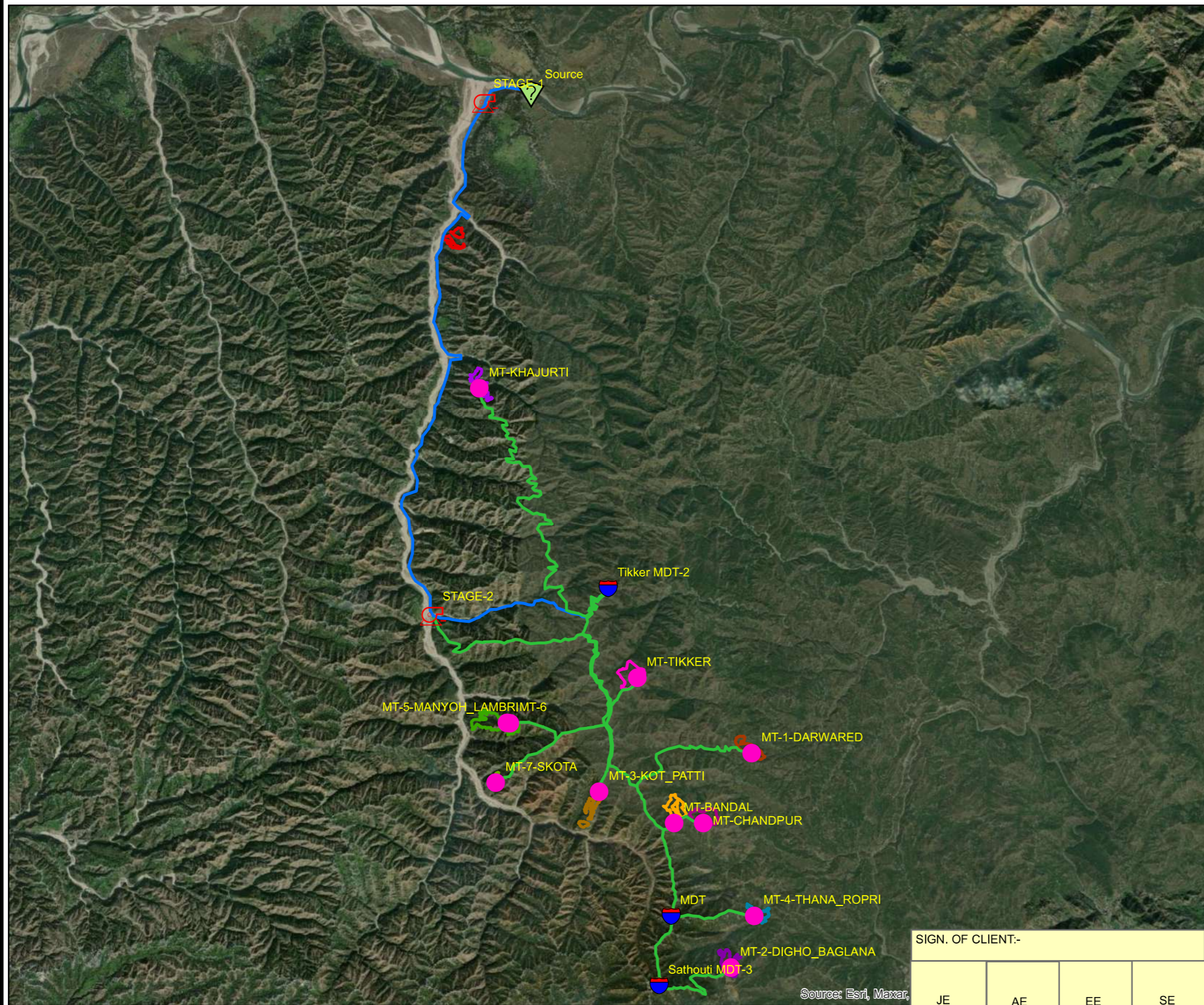

Legend

- Source
- MDT
- MT
- PUMP
- Rising Main
- Gravity Main
- DYOL
- KHAJURTI
- BANDAL
- TIKRI
- CHANDPUR
- SKOTA
- DIGHO_BAGLANA
- DARWARED
- KOT_PATTI
- THANA_ROPRI
- MANYOH_LAMBRI

Source: Esri, Maxar

SIGN. OF CLIENT:-

JE	AE	EE	SE
----	----	----	----

DETAILED DESIGN CONSULTANCY, HP-SHIVA (PACKAGE CS09)

IRRIGATION, HORTICULTURE, ORCHARDS AND VALUE CHAIN DEVELOPMENT

PURPOSE: FOR TENDER ONLY

TITLE:- KEY PLAN OF LIS TIHRA (PROPOSED)
(MANYOH-LAMBRI, THANNA(ROPARI), PATTI (KOT), DARWAAR, DIGHO-BAGLANA (KARYAL), SKOHTA, CHANDPUR, TIKRI, BANDAL, KHAJURTI, DYOL) DHARAMPUR BLOCK, MANDI DISTRICT.

Proprietary Notice and Version Control This document contains confidential information for use only by the "Client"; for the Project under consideration, which is provided for the sole purpose of permitting the recipient to evaluate the information submitted here with. In consideration of receipt of this document; unless agreed to in contrary in the Contract; the recipient agrees to maintain such information in confidence and to not reproduce or otherwise disclose this information to any person outside the recipient's organisation; except that there is no obligation to maintain the confidentiality of any information which was known to the recipient prior to receipt of such information from Tata Consulting Engineers Limited, or becomes publicly known through no fault of recipient, or Tata Consulting Engineers Limited, or is received without obligation of confidentiality from a third party owing no obligation of confidentiality to Tata Consulting Engineers Limited. All information given under this version overrides all and any kind of offers, assumptions, deliverables and contracts submitted verbally (and subsequently communicated in writing) or in writing or otherwise given under any and all previous version/s.

File Name: 12503A-CV-32124-Rev-P0

TATACONSULTING ENGINEERS LIMITED. MUMBAI

SCALE:- 1:100,000 DWG. No:- TCE.12503A-CV-3005-LM-32124 ISSUE:- P0
DL.CEN:- DEL-CV

SIGN.									13-06-2022	
	INITIALS									
REVISIONS										
P0	SIGN.									
	INITIALS	GKJ	ES	DVB		MK	DK			
REVISIONS										
ISSUE	DRN	DSN	CHD	CV	EL	IC	ME	PE/PM	APPD.	DATE
					CLEARED					

'P' (PRELIMINARY) ISSUES ARE NOT TO BE USED FOR CONSTRUCTION / FABRICATION BUT ARE ISSUED FOR LIMITED PURPOSES ONLY AS INDICATED IN THE SMALL BLOCK ABOVE THIS BLOCK.

CONSTRUCTION / FABRICATION WORK IS PERMITTED ON 'R' (RELEASED) ISSUES ONLY.

INFORMATION CONTAINED WITHIN 'HOLD' IS NOT RELEASED FOR CONSTRUCTION / FABRICATION. FIELD MUST GET DESIGN OFFICE TO CLEAR 'HOLDS' IN TIME BEFORE PROCEEDING WITH ANY CONSTRUCTION/FABRICATION WORK RELATED TO 'HOLDS'.

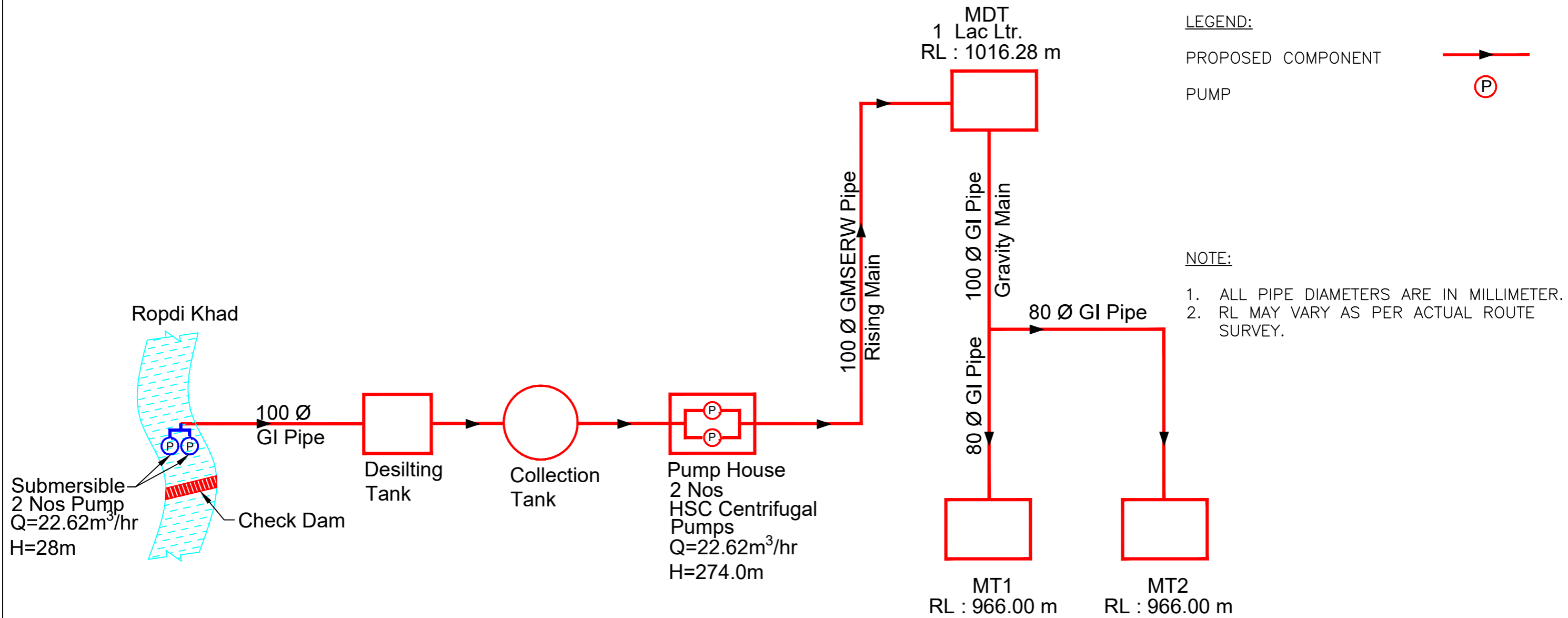

FLOW DIAGRAM – PROPOSED LIS GOLWAN (NEW SCHEME – 17.19 Ha)

P1	SIGN.																			
	INITIALS	SM	MJ	DVB						MK	DK	20-07-2022								
P0	SIGN.																			
	INITIALS	SM	MJ	DVB						MK	DK	01-06-2022								
ISSUE	DRN	DSN	CHD	CV	EL	IC	ME			PE/PM	APPD	DATE								
												(dd-mm-yyyy)								

'P' (PRELIMINARY) ISSUES ARE NOT TO BE USED FOR CONSTRUCTION / FABRICATION BUT ARE ISSUED FOR LIMITED PURPOSES ONLY AS INDICATED IN THE SMALL BLOCK ABOVE THIS BLOCK.

CONSTRUCTION / FABRICATION WORK IS PERMITTED ON 'R' (RELEASED) ISSUES ONLY.

INFORMATION CONTAINED WITHIN 'HOLD' IS NOT RELEASED FOR CONSTRUCTION / FABRICATION. FIELD MUST GET DESIGN OFFICE TO CLEAR 'HOLDS' IN TIME BEFORE PROCEEDING WITH ANY CONSTRUCTION/ FABRICATION WORK RELATED TO 'HOLDS'.

SIGN. OF CLIENT:—

JE	AE	EE	SE
----	----	----	----

PURPOSE: FOR TENDER ONLY

DO NOT SCALE

Proprietary Notice and Version Control This document contains confidential information for use only by the Client ; for the Project under consideration, which is provided for the sole purpose of permitting the recipient to evaluate the information submitted herewith, in consideration of receipt of this document unless agreed to in contrary in the Contract; the recipient agrees to maintain such information in confidence and to not reproduce or otherwise disclose this information to any person outside the recipient's organization; except that there is no obligation to maintain the confidentiality of any information which was known to the recipient prior to receipt of such information from Tata Consulting Engineers Limited, or becomes publicly known through no fault of recipient, or Tata Consulting Engineers Limited, or is received without obligation of confidentiality from a third party using no obligation of confidentiality to Tata Consulting Engineers Limited. All information given under this version over ideas of and any kind of offers, assumptions, observations and contracts submitted verbally (and subsequently communicated in writing) or in writing or otherwise given under any and all previous versions/.

FILE NAME 12503A-CV-32151-Rev-P1

DETAILED DESIGN CONSULTANCY, HP-SHIVA (PACKAGE CS09)

IRRIGATION, HORTICULTURE, ORCHARDS AND VALUE CHAIN DEVELOPMENT

FLOW DIAGRAM FOR PROPOSED LIS GOLWAN
CHAUNTARA BLOCK MANDI DISTRICT

 **TATA CONSULTING ENGINEERS LIMITED**
MUMBAI

SCALE : NTS DWG NO. TCE.12503A-CV-3082-FD-32151 ISSUE P1

DC & DISC: DEL-CV

LEGEND:

PROPOSED COMPONENT 

PUMP 

TUBEWELL 

NOTE:

- 1. ALL PIPE DIAMETERS ARE IN MILLIMETER.
- 2. RL MAY VARY AS PER ACTUAL ROUTE SURVEY.

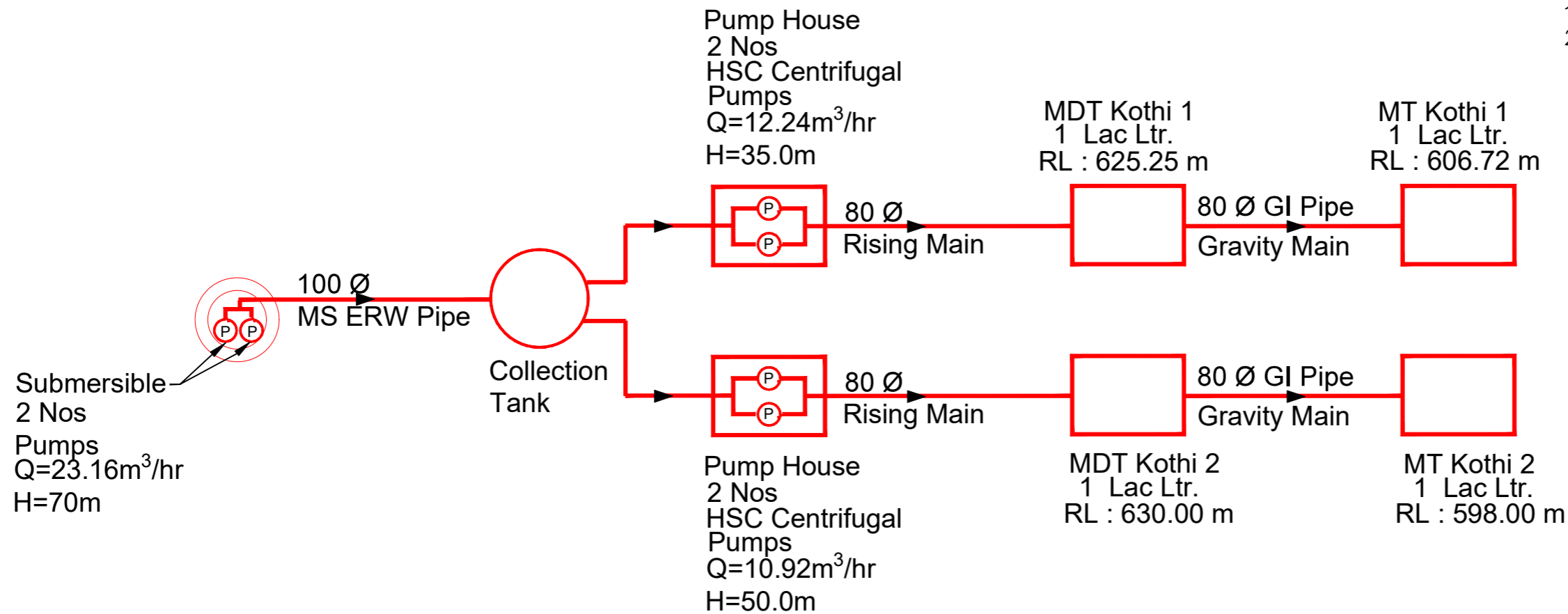

FLOW DIAGRAM – PROPOSED LIS FROM TW-1
(NEW SCHEME : KOTHI 1 – 9.30 Ha & KOTHI 2 – 8.3 Ha)

P1	SIGN.																						
	INITIALS	SM	MJ	DVB							MK	DK	20-07-2022										
REVISIONS		AS PER CLIENT COMMENTS																					
P0	SIGN.																						
	INITIALS	SM	MJ	DVB								MK	DK	01-06-2022									
REVISIONS																							
ISSUE		DRN	DSN	CHD	CV	EL	IC	ME			PE/PM	APPD	DATE										
														CLEARED									

'P' (PRELIMINARY) ISSUES ARE NOT TO BE USED FOR CONSTRUCTION / FABRICATION BUT ARE ISSUED FOR LIMITED PURPOSES ONLY AS INDICATED IN THE SMALL BLOCK ABOVE THIS BLOCK.

CONSTRUCTION / FABRICATION WORK IS PERMITTED ON 'R' (RELEASED) ISSUES ONLY.

INFORMATION CONTAINED WITHIN 'HOLD' IS NOT RELEASED FOR CONSTRUCTION / FABRICATION. FIELD MUST GET DESIGN OFFICE TO CLEAR 'HOLDS' IN TIME BEFORE PROCEEDING WITH ANY CONSTRUCTION/ FABRICATION WORK RELATED TO 'HOLDS'.

SIGN. OF CLIENT:–			
JE	AE	EE	SE
PURPOSE: FOR TENDER ONLY			
DO NOT SCALE			
<small>Proprietary Notice and Version Control This document contains confidential information for use only by the Client ; for the Project under consideration, which is provided for the sole purpose of permitting the recipient to evaluate the information submitted herewith, in consideration of receipt of this document, unless agreed to in contrary in the Contract; the recipient agrees to maintain such information in confidence and to not reproduce or otherwise disclose this information to any person outside the recipient's organization; except that there is no obligation to maintain the confidentiality of any information which was known to the recipient prior to receipt of such information from Tata Consulting Engineers Limited, or becomes publicly known through no fault of recipient, or Tata Consulting Engineers Limited, or is received without obligation of confidentiality from a third party using no obligation of confidentiality to Tata Consulting Engineers Limited. All information given under this version over rides all and any kind of offers, assumptions, deliberations and contracts submitted verbally (and subsequently communicated in writing) or in writing or otherwise given under any and all previous versions/s.</small>			
FILE NAME		12503A-CV-32152-Rev-P1	



DETAILED DESIGN CONSULTANCY, HP-SHIVA (PACKAGE CS09)
IRRIGATION, HORTICULTURE, ORCHARDS AND VALUE CHAIN DEVELOPMENT

FLOW DIAGRAM FOR PROPOSED LIS FROM TW-1
CHAUNTARA BLOCK MANDI DISTRICT



TATA CONSULTING ENGINEERS LIMITED
MUMBAI

SCALE : NTS	DWG NO. TCE.12503A-CV-3082-FD-32152	ISSUE P1
DC & DISC: DEL-CV		

LEGEND:

PROPOSED COMPONENT 

PUMP 

TUBEWELL 

NOTE:

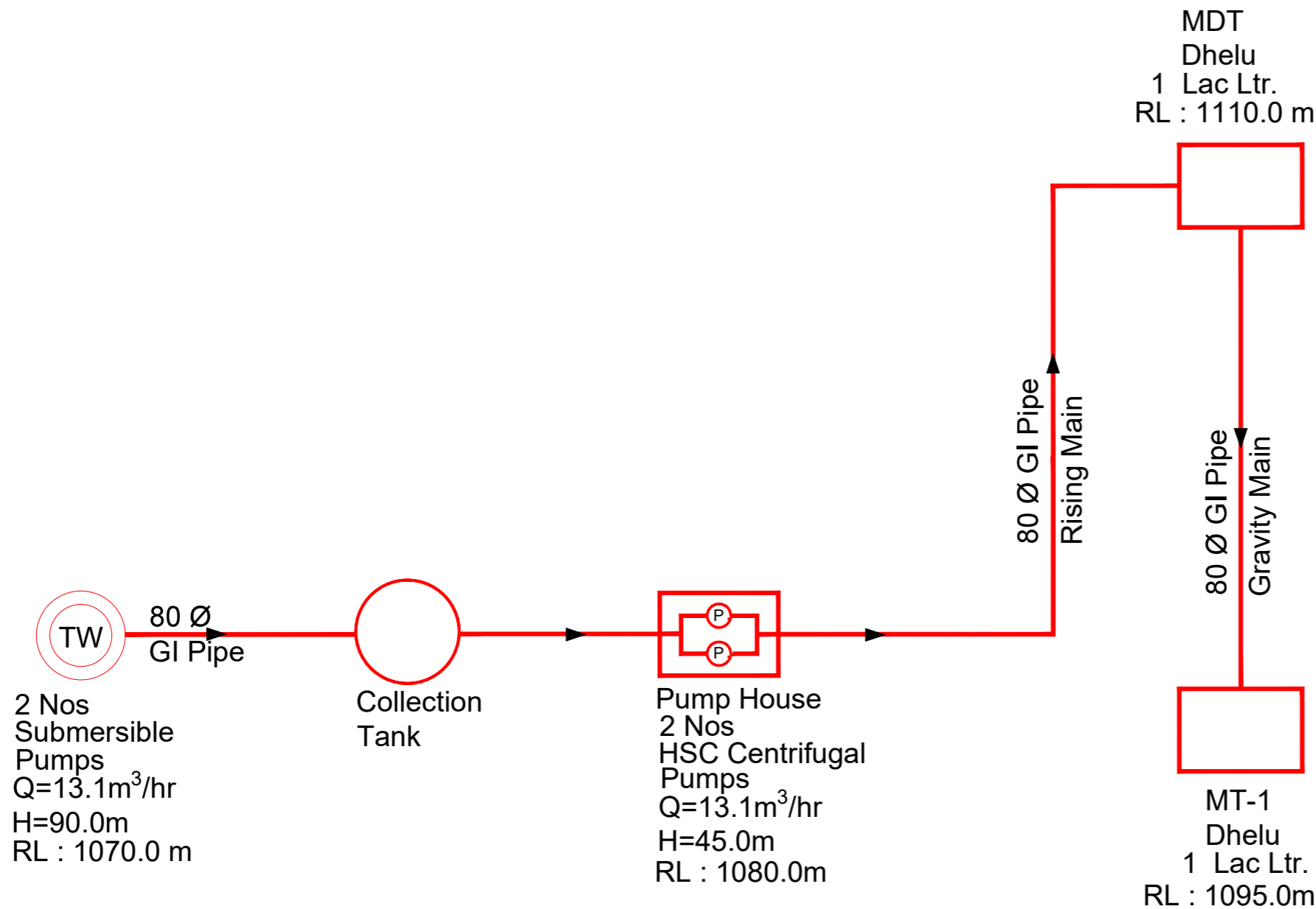

1. RL MAY VARY AS PER ACTUAL ROUTE SURVEY.



FLOW DIAGRAM – PROPOSED LIS DHELU (NEW SCHEME – 9.97 Ha)

P1	SIGN.																											
	INITIALS	SM	MJ	DVB									MK	DK	20-07-2022	'P' (PRELIMINARY) ISSUES ARE NOT TO BE USED FOR CONSTRUCTION / FABRICATION BUT ARE ISSUED FOR LIMITED PURPOSES ONLY AS INDICATED IN THE SMALL BLOCK ABOVE THIS BLOCK. CONSTRUCTION / FABRICATION WORK IS PERMITTED ON 'R' (RELEASED) ISSUES ONLY. INFORMATION CONTAINED WITHIN 'HOLD' IS NOT RELEASED FOR CONSTRUCTION / FABRICATION. FIELD MUST GET DESIGN OFFICE TO CLEAR 'HOLDS' IN TIME BEFORE PROCEEDING WITH ANY CONSTRUCTION/ FABRICATION WORK RELATED TO 'HOLDS'.												
REVISIONS	AS PER CLIENT COMMENTS																											
P0	SIGN.																											
	INITIALS	SM	MJ	DVB									MK	DK	01-06-2022													
REVISIONS																												
ISSUE		DRN	DSN	CHD	CV	EL	IC	ME				PE/PM	APPD	DATE														
														(dd-mm-yyyy)	CLEARED													

SIGN. OF CLIENT:—			
JE	AE	EE	SE
PURPOSE: FOR TENDER ONLY			
DO NOT SCALE			
<small>Proprietary Notice and Version Control This document contains confidential information for use only by the Client for the Project under consideration, which is provided for the sole purpose of permitting the recipient to evaluate the information submitted herewith, in consideration of receipt of this document unless agreed to in contrary in the Contract; the recipient agrees to maintain such information in confidence and to not reproduce or otherwise disclose this information to any person outside the recipient's organization; except that there is no obligation to maintain the confidentiality of any information which was known to the recipient prior to receipt of such information from Tata Consulting Engineers Limited, or becomes publicly known through no fault of recipient, or Tata Consulting Engineers Limited, or is received without obligation of confidentiality from a third party using no obligation of confidentiality to Tata Consulting Engineers Limited. All information given under this version over rides all and any kind of offers, assumptions, submissions and contracts submitted verbally (and subsequently communicated in writing) or in writing or otherwise given under any and all previous version/s.</small>			
FILE NAME		12503A-CV-32154-Rev-P1	

	DETAILED DESIGN CONSULTANCY, HP-SHIVA (PACKAGE CS09)	
	IRRIGATION, HORTICULTURE, ORCHARDS AND VALUE CHAIN DEVELOPMENT	
FLOW DIAGRAM PROPOSED FOR LIS DHELU CHAUNTARA BLOCK MANDI DISTRICT		
	TATA CONSULTING ENGINEERS LIMITED	
	MUMBAI	
SCALE : NTS	DWG NO. TCE.12503A-CV-3082-FD-32154	ISSUE P1
DC & DISC: DEL-CV		

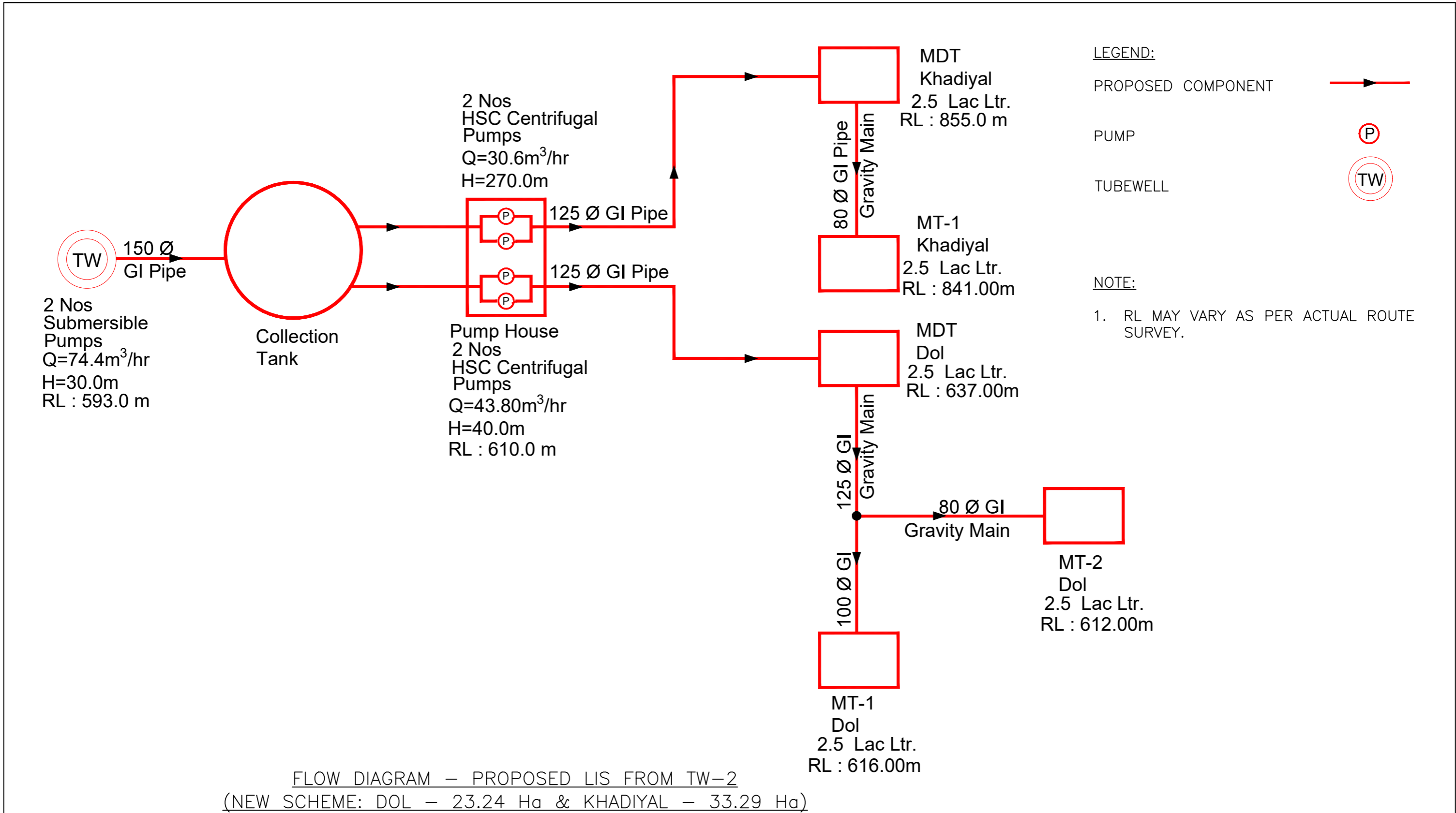

FLOW DIAGRAM – PROPOSED LIS FROM TW-2
 (NEW SCHEME: DOL – 23.24 Ha & KHADIYAL – 33.29 Ha)

DETAILED DESIGN CONSULTANCY, HP-SHIVA (PACKAGE CS09) IRRIGATION, HORTICULTURE, ORCHARDS AND VALUE CHAIN DEVELOPMENT																																																																																					
SIGN. OF CLIENT:- <table style="width: 100%; text-align: center;"> <tr> <td style="border: 1px solid black; width: 20%;"> </td> <td style="border: 1px solid black; width: 20%;"> </td> <td style="border: 1px solid black; width: 20%;"> </td> <td style="border: 1px solid black; width: 20%;"> </td> </tr> <tr> <td>JE</td> <td>AE</td> <td>EE</td> <td>SE</td> </tr> </table>					JE	AE	EE	SE	FLOW DIAGRAM FOR PROPOSED LIS FROM TW-2 CHAUNTARA BLOCK MANDI DISTRICT																																																																												
JE	AE	EE	SE																																																																																		
PURPOSE: FOR TENDER ONLY DO NOT SCALE																																																																																					
PROPRIETARY NOTICE AND VERSION CONTROL: This document contains confidential information for use only by the Client; for the Project under consideration, which is provided for the sole purpose of permitting the recipient to evaluate the information submitted herewith, in consideration of receipt of this document, unless agreed to in contrary in the Contract; the recipient agrees to maintain such information in confidence and to not reproduce or otherwise disclose this information to any person outside the recipient's organization; except that there is no obligation to maintain the confidentiality of any information which was known to the recipient prior to receipt of such information from Tata Consulting Engineers Limited, or becomes publicly known through no fault of recipient, or Tata Consulting Engineers Limited, or is received without obligation of confidentiality from a third party owing no obligation of confidentiality to Tata Consulting Engineers Limited. All information given under this version over rides all and any kind of offers, assumptions, submissions and contracts submitted verbally (and subsequently communicated in writing) or in writing or otherwise given under any and all previous versions/s.	TATA CONSULTING ENGINEERS LIMITED MUMBAI																																																																																				
<table border="1" style="width: 100%; border-collapse: collapse; text-align: center;"> <tr> <td>P1</td> <td>SIGN.</td> <td>SM</td> <td>MJ</td> <td>DVB</td> <td> </td> <td> </td> <td> </td> <td> </td> <td> </td> <td> </td> <td>MK</td> <td>DK</td> <td>20-07-2022</td> </tr> <tr> <td colspan="14">REVISIONS AS PER CLIENT COMMENTS</td> </tr> <tr> <td>P0</td> <td>SIGN.</td> <td>SM</td> <td>MJ</td> <td>DVB</td> <td> </td> <td> </td> <td> </td> <td> </td> <td> </td> <td> </td> <td>MK</td> <td>DK</td> <td>01-06-2022</td> </tr> <tr> <td colspan="14">REVISIONS</td> </tr> </table>	P1	SIGN.	SM	MJ	DVB							MK	DK	20-07-2022	REVISIONS AS PER CLIENT COMMENTS														P0	SIGN.	SM	MJ	DVB							MK	DK	01-06-2022	REVISIONS														<table border="1" style="width: 100%; border-collapse: collapse;"> <tr> <td>ISSUE</td> <td>DRN</td> <td>DSN</td> <td>CHD</td> <td>CV</td> <td>EL</td> <td>IC</td> <td>ME</td> <td> </td> <td> </td> <td>PE/PM</td> <td>APPD</td> <td>DATE</td> <td>(dd-mm-yyyy)</td> </tr> <tr> <td colspan="14" style="text-align: center;">CLEARED</td> </tr> </table>	ISSUE	DRN	DSN	CHD	CV	EL	IC	ME			PE/PM	APPD	DATE	(dd-mm-yyyy)	CLEARED													
P1	SIGN.	SM	MJ	DVB							MK	DK	20-07-2022																																																																								
REVISIONS AS PER CLIENT COMMENTS																																																																																					
P0	SIGN.	SM	MJ	DVB							MK	DK	01-06-2022																																																																								
REVISIONS																																																																																					
ISSUE	DRN	DSN	CHD	CV	EL	IC	ME			PE/PM	APPD	DATE	(dd-mm-yyyy)																																																																								
CLEARED																																																																																					
FILE NAME: F-093-Rev-R1.DWG																																																																																					
TCE FORM NO. 093 R1																																																																																					

LEGEND:

EXISTING COMPONENT



PERCOLATION WELL

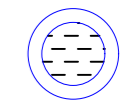

SOURCE



PUMP



NOTE:

1. ALL PIPE DIAMETERS ARE IN MILLIMETER.
2. RD & RL MAY VARY AS PER ACTUAL ROUTE SURVEY.

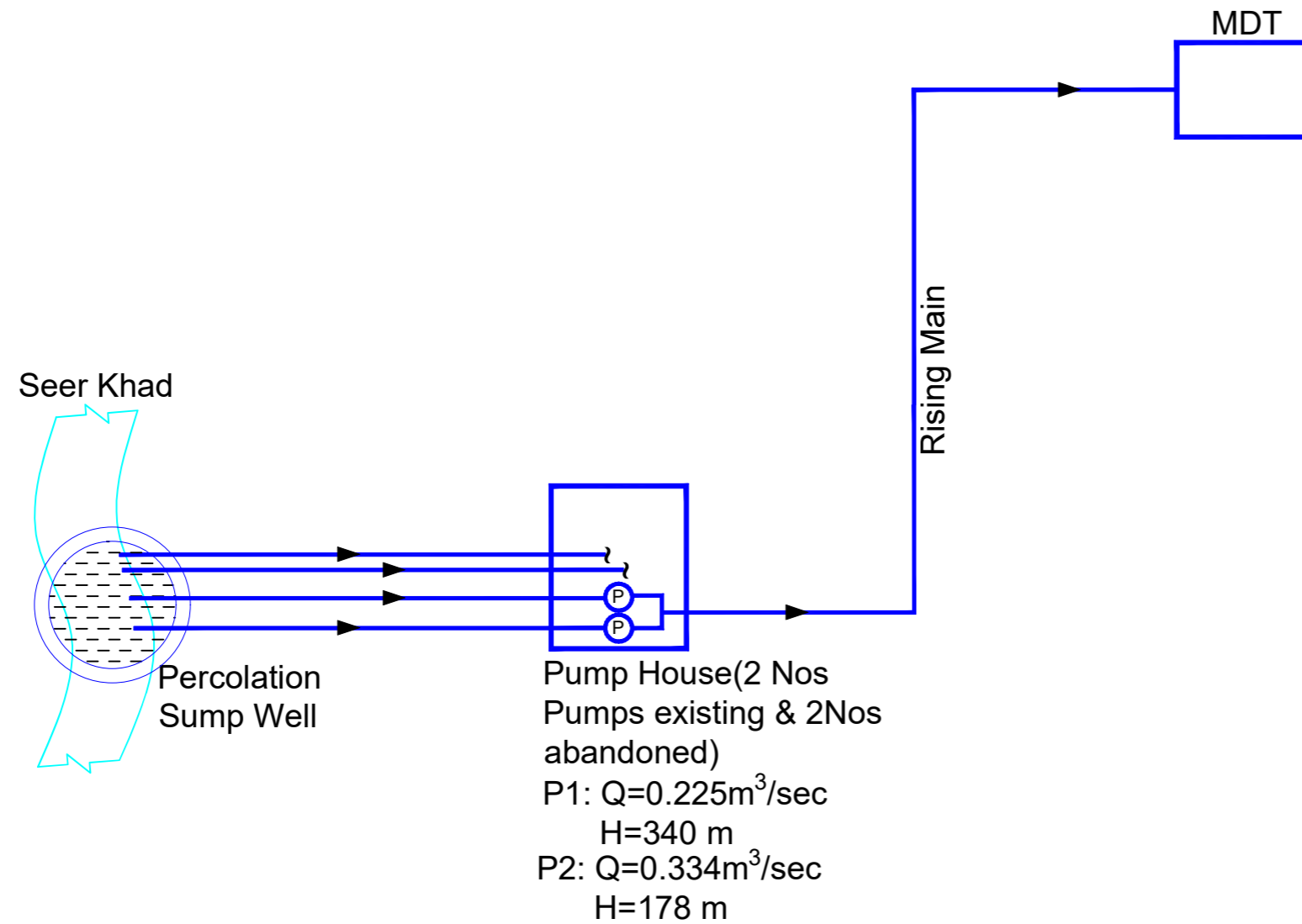

FLOW DIAGRAM – EXISTING LIS SULPUR BAHU (FUNCTIONAL SCHEME-7.50 Ha)

DETAILED DESIGN CONSULTANCY, HP-SHIVA (PACKAGE CS09)
 IRRIGATION, HORTICULTURE, ORCHARDS AND VALUE CHAIN DEVELOPMENT

FLOW DIAGRAM FOR EXISTING LIS SULPUR BAHU
 GOPALPUR BLOCK MANDI DISTRICT

TATA CONSULTING ENGINEERS LIMITED
 MUMBAI

SIGN. OF CLIENT:-

JE	AE	EE	SE
----	----	----	----

PURPOSE: FOR TENDER ONLY

DO NOT SCALE

Proprietary Notice and Version Control This document contains confidential information for use only by the Client; for the Project under consideration, which is provided for the sole purpose of permitting the recipient to evaluate the information submitted hereon, in consideration of receipt of this document, unless agreed to in contrary in the Contract; the recipient agrees to maintain such information in confidence and to not reproduce or otherwise disclose this information to any person outside the recipient's organization; except that there is no obligation to maintain the confidentiality of any information which was known to the recipient prior to receipt of such information from Tata Consulting Engineers Limited, or becomes publicly known through no fault of recipient, or Tata Consulting Engineers Limited, or is received without obligation of confidentiality from a third party using no obligation of confidentiality to Tata Consulting Engineers Limited. All information given under this version over time and any kind of offers, exemptions, deliberations and contracts submitted verbally (and subsequently communicated in writing) or in writing or otherwise given under any and all previous version/s.

SIGN.											
	INITIALS										
	REVISIONS										
PO	SIGN.										
	INITIALS	SM	MJ	DVB					MK	MJ	01-06-2022
	REVISIONS										
ISSUE	DRN	DSN	CHD	CV	EL	IC	ME		PE/PM	APPD	DATE
	CLEARED										(dd-mm-yyyy)

'P' (PRELIMINARY) ISSUES ARE NOT TO BE USED FOR CONSTRUCTION / FABRICATION BUT ARE ISSUED FOR LIMITED PURPOSES ONLY AS INDICATED IN THE SMALL BLOCK ABOVE THIS BLOCK.

CONSTRUCTION / FABRICATION WORK IS PERMITTED ON 'R' (RELEASED) ISSUES ONLY.

INFORMATION CONTAINED WITHIN 'HOLD' IS NOT RELEASED FOR CONSTRUCTION / FABRICATION. FIELD MUST GET DESIGN OFFICE TO CLEAR 'HOLDS' IN TIME BEFORE PROCEEDING WITH ANY CONSTRUCTION/ FABRICATION WORK RELATED TO 'HOLDS'.

FILE NAME 12503A-CV-32156-Rev-P0

SCALE : NTS DWG NO. TCE.12503A-CV-3082-FD-32156 ISSUE PO

LEGEND:

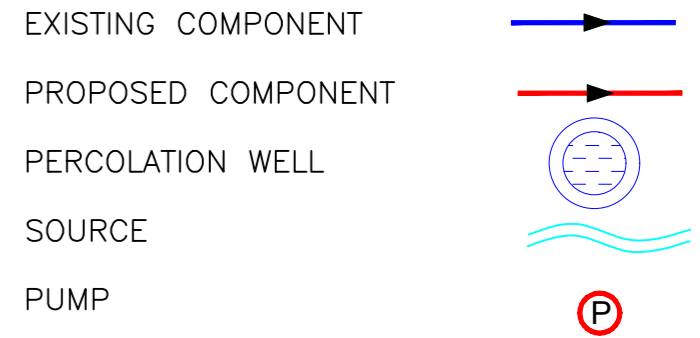

NOTE:

1. ALL PIPE DIAMETERS ARE IN MILLIMETER.
2. RD & RL MAY VARY AS PER ACTUAL ROUTE SURVEY.

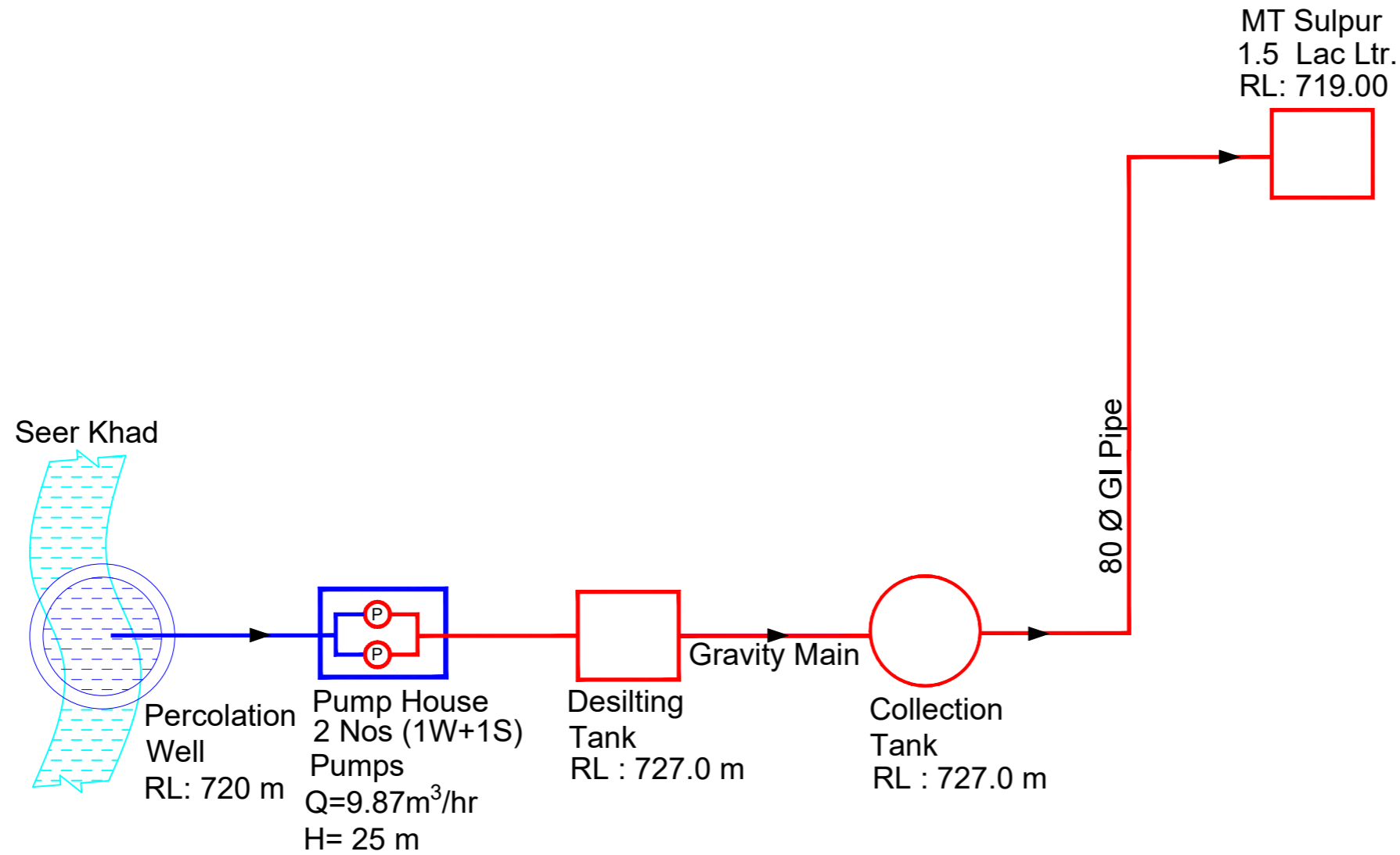

FLOW DIAGRAM – PROPOSED LIS SULPUR BAHU (FUNCTIONAL SCHEME – 7.50 Ha)

P1	SIGN.																											
	INITIALS	SM	MJ	DVB									MK	DK	20-07-2022	'P' (PRELIMINARY) ISSUES ARE NOT TO BE USED FOR CONSTRUCTION / FABRICATION BUT ARE ISSUED FOR LIMITED PURPOSES ONLY AS INDICATED IN THE SMALL BLOCK ABOVE THIS BLOCK. CONSTRUCTION / FABRICATION WORK IS PERMITTED ON 'R' (RELEASED) ISSUES ONLY. INFORMATION CONTAINED WITHIN 'HOLD' IS NOT RELEASED FOR CONSTRUCTION / FABRICATION. FIELD MUST GET DESIGN OFFICE TO CLEAR 'HOLDS' IN TIME BEFORE PROCEEDING WITH ANY CONSTRUCTION/ FABRICATION WORK RELATED TO 'HOLDS'.												
REVISIONS	AS PER CLIENT COMMENTS																											
PO	SIGN.																											
	INITIALS	SM	MJ	DVB									MK	DK	01-06-2022													
REVISIONS																												
ISSUE		DRN	DSN	CHD	CV	EL	IC	ME				PE/PM	APPD	DATE	((dd-mm-yyyy)) CV EL IC ME PE/PM APPD DATE CLEARED													

SIGN. OF CLIENT: -			
JE	AE	EE	SE
PURPOSE: FOR TENDER ONLY			
DO NOT SCALE			
<small>Proprietary Notice and Version Control: This document contains confidential information for use only by the Client for the Project under consideration, which is provided for the sole purpose of permitting the recipient to evaluate the information submitted herewith. In consideration of receipt of this document, unless agreed to in writing by the Client, the recipient agrees to maintain such information in confidence and to not reproduce or otherwise disclose this information to any person outside the recipient's organization except that there is no obligation to maintain the confidentiality of any information which was known to the recipient prior to receipt of such information from Tata Consulting Engineers Limited, or becomes publicly known through no fault of recipient, or Tata Consulting Engineers Limited, or is received without obligation of confidentiality from a third party using no obligation of confidentiality to Tata Consulting Engineers Limited. All information given under this version over takes all and any kind of offers, quotations, deliberations and contracts submitted verbally (and subsequently communicated in writing) or in writing or otherwise given under any and all previous versions/.</small>			
FILE NAME		12503A-CV-32157-Rev-P1	

	DETAILED DESIGN CONSULTANCY, HP-SHIVA (PACKAGE CS09) IRRIGATION, HORTICULTURE, ORCHARDS AND VALUE CHAIN DEVELOPMENT	
	FLOW DIAGRAM FOR PROPOSED LIS SULPUR BAHU GOPALPUR BLOCK MANDI DISTRICT	
SCALE : NTS	DWG NO. TCE.12503A-CV-3082-FD-32157	ISSUE P1
DC & DISC: DEL-CV		

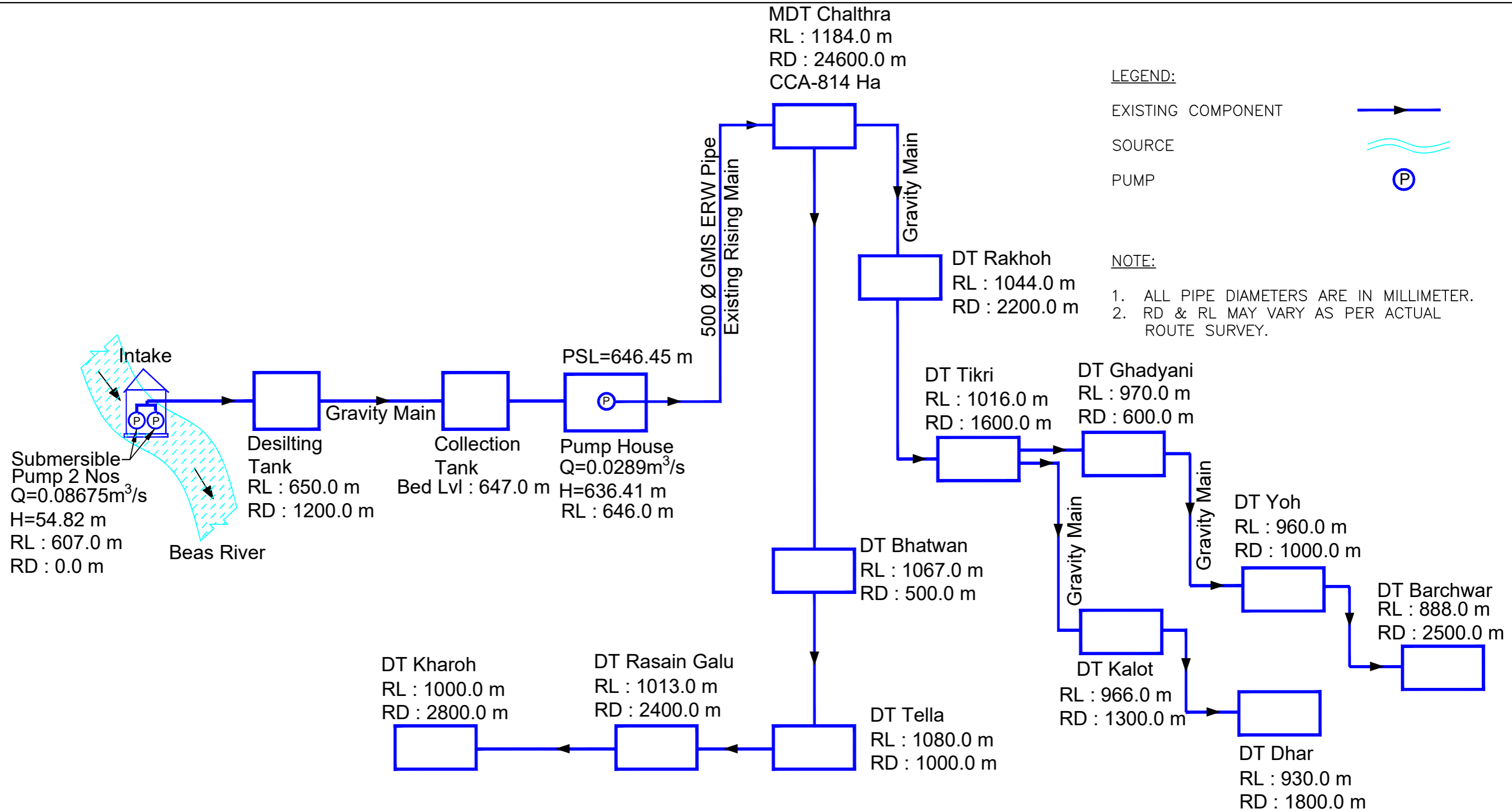

FLOW DIAGRAM – EXISTING LIS BASANTPUR (FUNCTIONAL SCHEME)

DETAILED DESIGN CONSULTANCY, HP-SHIVA (PACKAGE CS09) IRRIGATION, HORTICULTURE, ORCHARDS AND VALUE CHAIN DEVELOPMENT													
FLOW DIAGRAM FOR EXISTING LIS BASANTPUR GOPALPUR BLOCK MANDI DISTRICT													
SIGN.					SIGN. OF CLIENT:-								
INITIALS					<table border="1" style="width:100%; height: 20px;"> <tr> <td>JE</td> <td>AE</td> <td>EE</td> <td>SE</td> </tr> </table>					JE	AE	EE	SE
JE	AE	EE	SE										
REVISIONS					PURPOSE: FOR TENDER ONLY								
SIGN.					DO NOT SCALE								
INITIALS					<small>Proprietary Notice and Version Control This document contains confidential information for use only by the Client. For the Project under consideration, which is provided for the sole purpose of permitting the recipient to evaluate the information submitted hereon, in consideration of receipt of this document, unless agreed to in contrary in the Contract, the recipient agrees to maintain such information in confidence and to not reproduce or otherwise disclose this information to any person outside the recipient's organization, except that there is no obligation to maintain the confidentiality of any information which was known to the recipient prior to receipt of such information from Tata Consulting Engineers Limited, or becomes publicly known through no fault of recipient, or Tata Consulting Engineers Limited, or is received without obligation of confidentiality from a third party using no obligation of confidentiality to Tata Consulting Engineers Limited. All information given under this version over time and any kind of offers, conceptions, deliberations and contracts submitted verbally (and subsequently communicated in writing) or in writing or otherwise given under any and all previous versions/s.</small>								
REVISIONS					TATA CONSULTING ENGINEERS LIMITED MUMBAI								
PO	SIGN.	SM	MJ	DVB	MJ	DK	01-06-2022	CONSTRUCTION / FABRICATION WORK IS PERMITTED ON 'R' (RELEASED) ISSUES ONLY.					
ISSUE	DRN	DSN	CHD	CV	EL	IC	ME	PE/PM	APPD				
				CLEARED				DATE					
INFORMATION CONTAINED WITHIN 'HOLD' IS NOT RELEASED FOR CONSTRUCTION / FABRICATION. FIELD MUST GET DESIGN OFFICE TO CLEAR 'HOLDS' IN TIME BEFORE PROCEEDING WITH ANY CONSTRUCTION/ FABRICATION WORK RELATED TO 'HOLDS'.													
FILE NAME					TCE.12503A-CV-32158-Rev-P0								
SCALE					: NTS								
DC & DISC					DEL-CV								
DWG NO.					TCE.12503A-CV-3082-FD-32158								
ISSUE					PO								

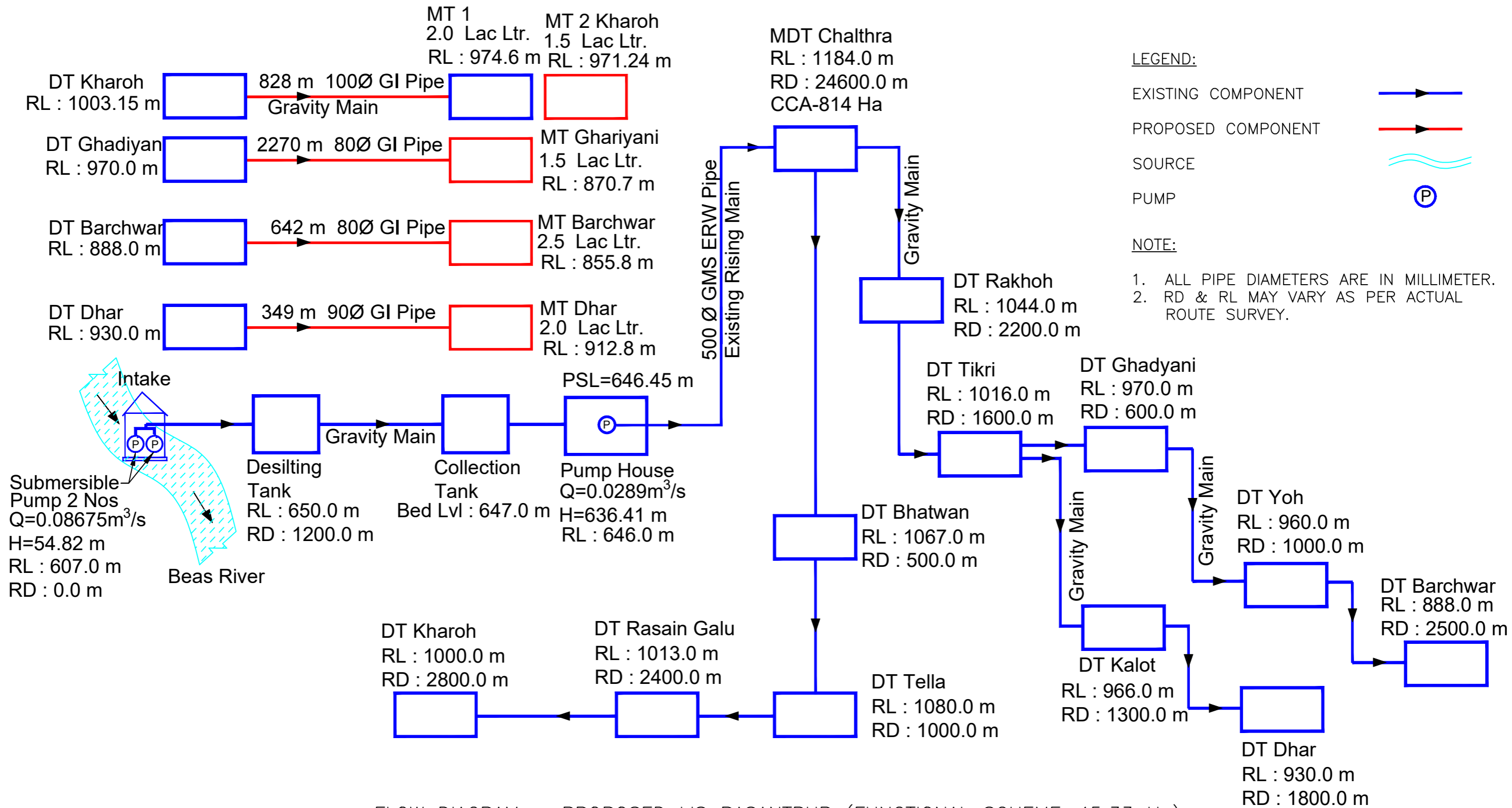

FLOW DIAGRAM – PROPOSED LIS BASANTPUR (FUNCTIONAL SCHEME-45.33 Ha)

SIGN. OF CLIENT:-		DETAILED DESIGN CONSULTANCY, HP-SHIVA (PACKAGE CS09) IRRIGATION, HORTICULTURE, ORCHARDS AND VALUE CHAIN DEVELOPMENT	
JE AE EE SE PURPOSE: FOR TENDER ONLY DO NOT SCALE		FLOW DIAGRAM FOR PROPOSED LIS BASANTPUR GOPALPUR BLOCK MANDI DISTRICT	
PROPRIETARY NOTICE AND VERSION CONTROL: This document contains confidential information for use only by the Client. For the Project under consideration, which is provided for the sole purpose of permitting the recipient to evaluate the information submitted herewith, in consideration of receipt of this document, the recipient agrees to maintain such information in confidence and to not reproduce or otherwise disclose this information to any person outside the recipient's organization, except that there is no obligation to maintain the confidentiality of any information which was known to the recipient prior to receipt of such information from Tata Consulting Engineers Limited, or becomes publicly known through no fault of recipient, or Tata Consulting Engineers Limited, or is received without obligation of confidentiality from a third party owing no obligation of confidentiality to Tata Consulting Engineers Limited. All information given under this version over rides all and any kind of offers, assumptions, omissions and contracts submitted verbally (and subsequently communicated in writing) or in writing or otherwise given under any and all previous versions/s.		TATA CONSULTING ENGINEERS LIMITED MUMBAI	
SCALE : NTS DWG NO. TCE.12503A-CV-3082-FD-32159 ISSUE P1		FILE NAME 12503A-CV-32159-Rev-P1 DC & DISC: DEL-CV	

P1	SIGN.	SM	MJ	DVB								MK	DK	20-07-2022	'P' (PRELIMINARY) ISSUES ARE NOT TO BE USED FOR CONSTRUCTION / FABRICATION BUT ARE ISSUED FOR LIMITED PURPOSES ONLY AS INDICATED IN THE SMALL BLOCK ABOVE THIS BLOCK.
	REVISIONS	AS PER CLIENT COMMENTS													
P0	SIGN.	SM	MJ	DVB								MJ	DK	01-06-2022	CONSTRUCTION / FABRICATION WORK IS PERMITTED ON 'R' (RELEASED) ISSUES ONLY. INFORMATION CONTAINED WITHIN 'HOLD' IS NOT RELEASED FOR CONSTRUCTION / FABRICATION. FIELD MUST GET DESIGN OFFICE TO CLEAR 'HOLDS' IN TIME BEFORE PROCEEDING WITH ANY CONSTRUCTION/ FABRICATION WORK RELATED TO 'HOLDS'.
	REVISIONS														
ISSUE	DRN	DSN	CHD	CV	EL	IC	ME			PE/PM	APPD	DATE	(dd-mm-yyyy)		
CV EL IC ME PE/PM APPD DATE (dd-mm-yyyy)															

FILE NAME: F-093-Rev-R1.DWG TCE FORM NO. 093 R1

LEGEND:

EXISTING COMPONENT 

SOURCE 

PUMP 

NOTE:

1. ALL PIPE DIAMETERS ARE IN MILLIMETER.
2. RL MAY VARY AS PER ACTUAL ROUTE SURVEY.

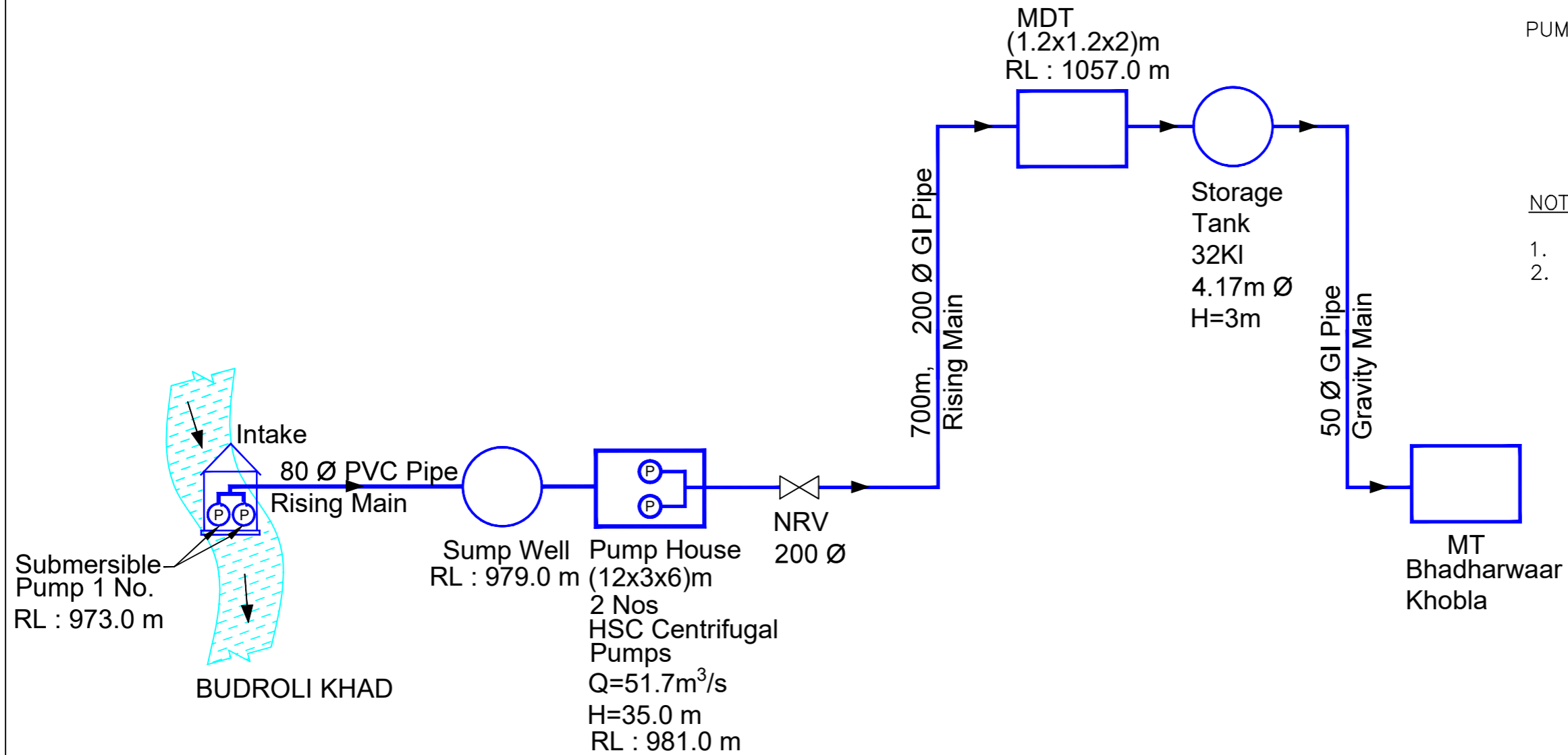

FLOW DIAGRAM – EXISTING LIS BHADHARWAAR, BHUDROLI (FUNCTIONAL SCHEME)

 DETAILED DESIGN CONSULTANCY, HP-SHIVA (PACKAGE CS09)
IRRIGATION, HORTICULTURE, ORCHARDS AND VALUE CHAIN DEVELOPMENT

FLOW DIAGRAM FOR EXISTING LIS BHADHARWAAR, BHUDROLI KHAD
GOPALPUR BLOCK MANDI DISTRICT

SIGN. OF CLIENT:-

JE	AE	EE	SE
----	----	----	----

PURPOSE: FOR TENDER ONLY

DO NOT SCALE

 **TATA CONSULTING ENGINEERS LIMITED**
MUMBAI

SIGN.											
	INITIALS										
	REVISIONS										
PO	SIGN.										
	SM	MJ	DVB					MJ	DK	01-06-2022	
	REVISIONS										
ISSUE	DRN	DSN	CHD	CV	EL	IC	ME		PE/PM	APPD	DATE
	CLEARED										(dd-mm-yyyy)

'P' (PRELIMINARY) ISSUES ARE NOT TO BE USED FOR CONSTRUCTION / FABRICATION BUT ARE ISSUED FOR LIMITED PURPOSES ONLY AS INDICATED IN THE SMALL BLOCK ABOVE THIS BLOCK.

CONSTRUCTION / FABRICATION WORK IS PERMITTED ON 'R' (RELEASED) ISSUES ONLY.

INFORMATION CONTAINED WITHIN 'HOLD' IS NOT RELEASED FOR CONSTRUCTION / FABRICATION. FIELD MUST GET DESIGN OFFICE TO CLEAR 'HOLDS' IN TIME BEFORE PROCEEDING WITH ANY CONSTRUCTION/ FABRICATION WORK RELATED TO 'HOLDS'.

Proprietary Notice and Version Control: This document contains confidential information for use only by the Client. For the Project under consideration, which is provided for the sole purpose of permitting the recipient to evaluate the information submitted hereunder, in consideration of receipt of this document, unless agreed to in contrary in the Contract, the recipient agrees to maintain such information in confidence and to not reproduce or otherwise disclose this information to any person outside the recipient's organization, except that there is no obligation to maintain the confidentiality of any information which was known to the recipient prior to receipt of such information from Tata Consulting Engineers Limited, or becomes publicly known through no fault of recipient, or Tata Consulting Engineers Limited, or is received without obligation of confidentiality from a third party using no obligation of confidentiality to Tata Consulting Engineers Limited. All information given under this version over rules all and any kind of offers, correspondence, deliberations and contracts submitted verbally (and subsequently communicated in writing) or in writing or otherwise given under any and all previous version/s.

FILE NAME 12503A-CV-32160-Rev-P0

SCALE : NTS DWG NO. TCE.12503A-CV-3082-FD-32160 ISSUE PO
DC & DISC: DEL-CV

LEGEND:

- EXISTING COMPONENT
- PROPOSED COMPONENT
- SOURCE
- PUMP

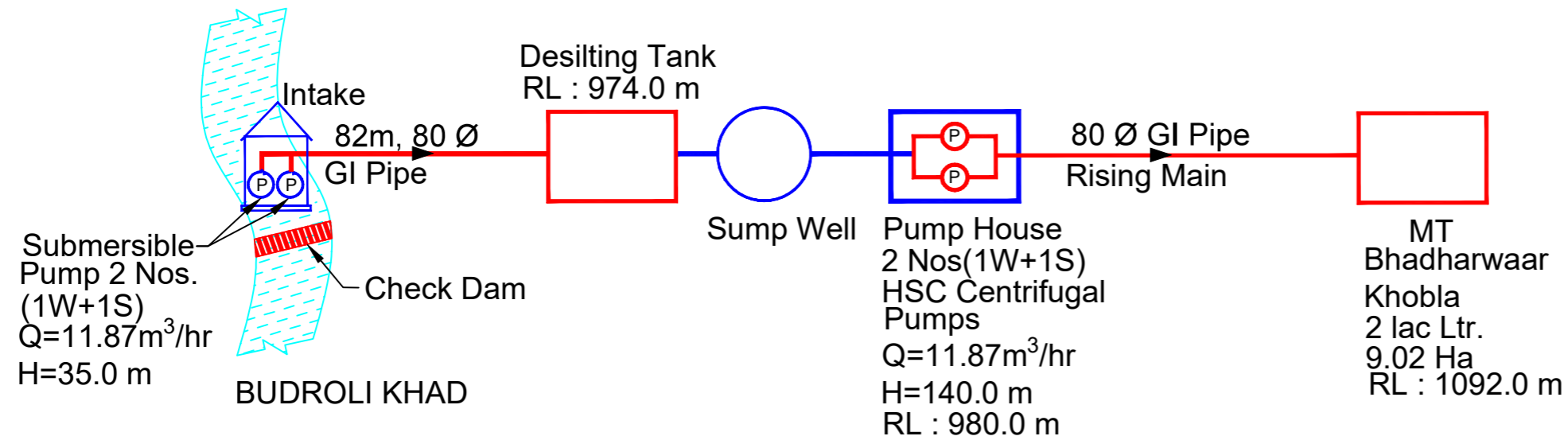

NOTE:

- ALL PIPE DIAMETERS ARE IN MILLIMETER.
- RL MAY VARY AS PER ACTUAL ROUTE SURVEY.

FLOW DIAGRAM – PROPOSED LIS BHADHARWAAR, BHUDROLI (FUNCTIONAL SCHEME-9.02 Hd)

P1	SIGN.												20-07-2022	
	INITIALS	SM	MJ	DVB								MK		DK
REVISIONS		AS PER CLIENT COMMENTS												
P0	SIGN.												01-06-2022	
	INITIALS	SM	MJ	DVB								MJ		DK
REVISIONS														
ISSUE		DRN	DSN	CHD	CV	EL	IC	ME			PE/PM	APPD	DATE	(dd-mm-yyyy)
													CLEARED	

'P' (PRELIMINARY) ISSUES ARE NOT TO BE USED FOR CONSTRUCTION / FABRICATION BUT ARE ISSUED FOR LIMITED PURPOSES ONLY AS INDICATED IN THE SMALL BLOCK ABOVE THIS BLOCK.

CONSTRUCTION / FABRICATION WORK IS PERMITTED ON 'R' (RELEASED) ISSUES ONLY.

INFORMATION CONTAINED WITHIN 'HOLD' IS NOT RELEASED FOR CONSTRUCTION / FABRICATION. FIELD MUST GET DESIGN OFFICE TO CLEAR 'HOLDS' IN TIME BEFORE PROCEEDING WITH ANY CONSTRUCTION/ FABRICATION WORK RELATED TO 'HOLDS'.

SIGN. OF CLIENT:—

JE	AE	EE	SE

PURPOSE: FOR TENDER ONLY

DO NOT SCALE

Proprietary Notice and Version Control This document contains confidential information for use only by the Client for the Project under consideration, which is provided for the sole purpose of permitting the recipient to evaluate the information submitted herewith. In consideration of receipt of this document, the recipient agrees to maintain such information in confidence and to not reproduce or otherwise disclose this information to any person outside the recipient's organization, except that there is no obligation to maintain the confidentiality of any information which was known to the recipient prior to receipt of such information from Tata Consulting Engineers Limited, or becomes publicly known through no fault of recipient, or Tata Consulting Engineers Limited, or is received without obligation of confidentiality from a third party using no obligation of confidentiality to Tata Consulting Engineers Limited. All information given under this version over time and any kind of offers, assumptions, alterations and contracts submitted verbally (and subsequently communicated in writing) or in writing or otherwise given under any and all previous versions/s.

FILE NAME 12503A-CV-32161-Rev-P1

DETAILED DESIGN CONSULTANCY, HP-SHIVA (PACKAGE CS09)
IRRIGATION, HORTICULTURE, ORCHARDS AND VALUE CHAIN DEVELOPMENT

FLOW DIAGRAM FOR PROPOSED LIS BHADHARWAAR, BHUDROLI KHAD
GOPALPUR BLOCK MANDI DISTRICT

TATA CONSULTING ENGINEERS LIMITED
MUMBAI

SCALE : NTS	DWG NO. TCE.12503A-CV-3082-FD-32161	ISSUE P1
DC & DISC: DEL-CV		

LEGEND:

PROPOSED COMPONENT



INFILTRATION GALLERY

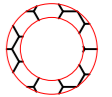

SOURCE



PUMP



NOTE:

1. ALL PIPE DIAMETERS ARE IN MILLIMETER.
2. RD & RL MAY VARY AS PER ACTUAL ROUTE SURVEY.

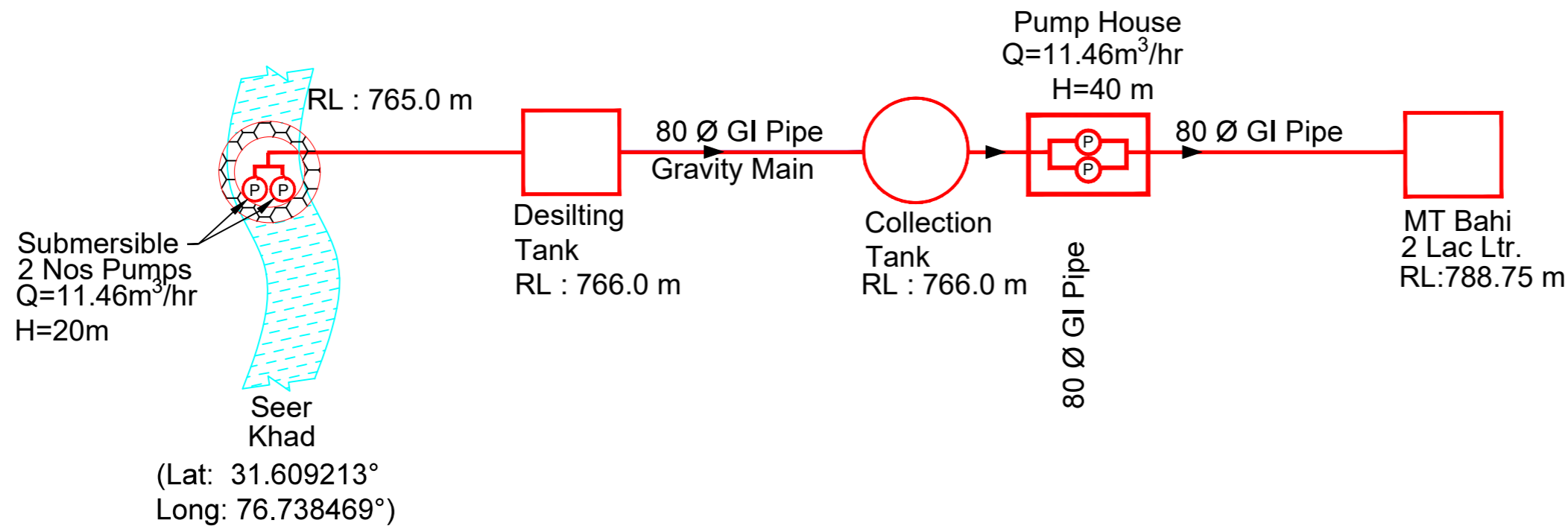

FLOW DIAGRAM – PROPOSED LIS PERCOLATION SEER KHAD (FUNCTIONAL – 8.71 Ha)

<table border="1"> <tr> <td>P1</td> <td>SIGN.</td> <td></td><td></td><td></td><td></td><td></td><td></td><td></td><td></td><td></td><td></td> </tr> <tr> <td></td> <td>INITIALS</td> <td>SM</td><td>MJ</td><td>DVB</td><td></td><td></td><td></td><td></td><td></td><td>MK</td><td>DK</td> </tr> <tr> <td></td> <td>REVISIONS</td> <td colspan="10">AS PER CLIENT COMMENTS</td> </tr> <tr> <td>P0</td> <td>SIGN.</td> <td></td><td></td><td></td><td></td><td></td><td></td><td></td><td></td><td></td><td></td> </tr> <tr> <td></td> <td>INITIALS</td> <td>SM</td><td>MJ</td><td>DVB</td><td></td><td></td><td></td><td></td><td></td><td>MK</td><td>DK</td> </tr> <tr> <td></td> <td>REVISIONS</td> <td colspan="10"></td> </tr> </table>												P1	SIGN.												INITIALS	SM	MJ	DVB						MK	DK		REVISIONS	AS PER CLIENT COMMENTS										P0	SIGN.												INITIALS	SM	MJ	DVB						MK	DK		REVISIONS											<p>'P' (PRELIMINARY) ISSUES ARE NOT TO BE USED FOR CONSTRUCTION / FABRICATION BUT ARE ISSUED FOR LIMITED PURPOSES ONLY AS INDICATED IN THE SMALL BLOCK ABOVE THIS BLOCK.</p> <p>CONSTRUCTION / FABRICATION WORK IS PERMITTED ON 'R' (RELEASED) ISSUES ONLY.</p> <p>INFORMATION CONTAINED WITHIN 'HOLD' IS NOT RELEASED FOR CONSTRUCTION / FABRICATION. FIELD MUST GET DESIGN OFFICE TO CLEAR 'HOLDS' IN TIME BEFORE PROCEEDING WITH ANY CONSTRUCTION/ FABRICATION WORK RELATED TO 'HOLDS'.</p>												<p>Proprietary Notice and Version Control This document contains confidential information for use only by the Client; for the Project under consideration, which is provided for the sole purpose of permitting the recipient to evaluate the information submitted herewith, in consideration of receipt of this document, unless agreed to in contrary in the Contract; the recipient agrees to maintain such information in confidence and to not reproduce or otherwise disclose this information to any person outside the recipient's organization; except that there is no obligation to maintain the confidentiality of any information which was known to the recipient prior to receipt of such information from Tata Consulting Engineers Limited, or becomes publicly known through no fault of recipient, or Tata Consulting Engineers Limited, or is received without obligation of confidentiality from a third party owing no obligation of confidentiality to Tata Consulting Engineers Limited. All information given under this version over rides all and any kind of offers, assumptions, deliberations and contracts submitted verbally (and subsequently communicated in writing) or in writing or otherwise given under any and all previous versions/s.</p>												<p>FILE NAME 12503A-CV-32162-Rev-P1</p>											
P1	SIGN.																																																																																																																						
	INITIALS	SM	MJ	DVB						MK	DK																																																																																																												
	REVISIONS	AS PER CLIENT COMMENTS																																																																																																																					
P0	SIGN.																																																																																																																						
	INITIALS	SM	MJ	DVB						MK	DK																																																																																																												
	REVISIONS																																																																																																																						
<table border="1"> <tr> <td colspan="12">SIGN. OF CLIENT:-</td> </tr> <tr> <td colspan="12"> <table border="1"> <tr> <td>JE</td><td>AE</td><td>EE</td><td>SE</td> </tr> </table> </td> </tr> <tr> <td colspan="12">PURPOSE: FOR TENDER ONLY</td> </tr> <tr> <td colspan="12">DO NOT SCALE</td> </tr> </table>												SIGN. OF CLIENT:-												<table border="1"> <tr> <td>JE</td><td>AE</td><td>EE</td><td>SE</td> </tr> </table>												JE	AE	EE	SE	PURPOSE: FOR TENDER ONLY												DO NOT SCALE												<p>DETAILED DESIGN CONSULTANCY, HP-SHIVA (PACKAGE CS09) IRRIGATION, HORTICULTURE, ORCHARDS AND VALUE CHAIN DEVELOPMENT</p> <p>FLOW DIAGRAM FOR PROPOSED LIS PERCOLATION SEER KHAD GOPALPUR BLOCK MANDI DISTRICT</p>												<p>SCALE : NTS DWG NO. TCE.12503A-CV-3082-FD-32162 ISSUE P1</p>																																											
SIGN. OF CLIENT:-																																																																																																																							
<table border="1"> <tr> <td>JE</td><td>AE</td><td>EE</td><td>SE</td> </tr> </table>												JE	AE	EE	SE																																																																																																								
JE	AE	EE	SE																																																																																																																				
PURPOSE: FOR TENDER ONLY																																																																																																																							
DO NOT SCALE																																																																																																																							
<p>ISSUE DRN DSN CHD CV EL IC ME PE/PM APPD DATE</p>												<p>DC & DISC: DEL-CV</p>												<p>TATA CONSULTING ENGINEERS LIMITED MUMBAI</p>																																																																																															

LEGEND:

PROPOSED COMPONENT



SOURCE



NOTE:

1. ALL PIPE DIAMETERS ARE IN MILLIMETER.
2. RL MAY VARY AS PER ACTUAL ROUTE SURVEY.

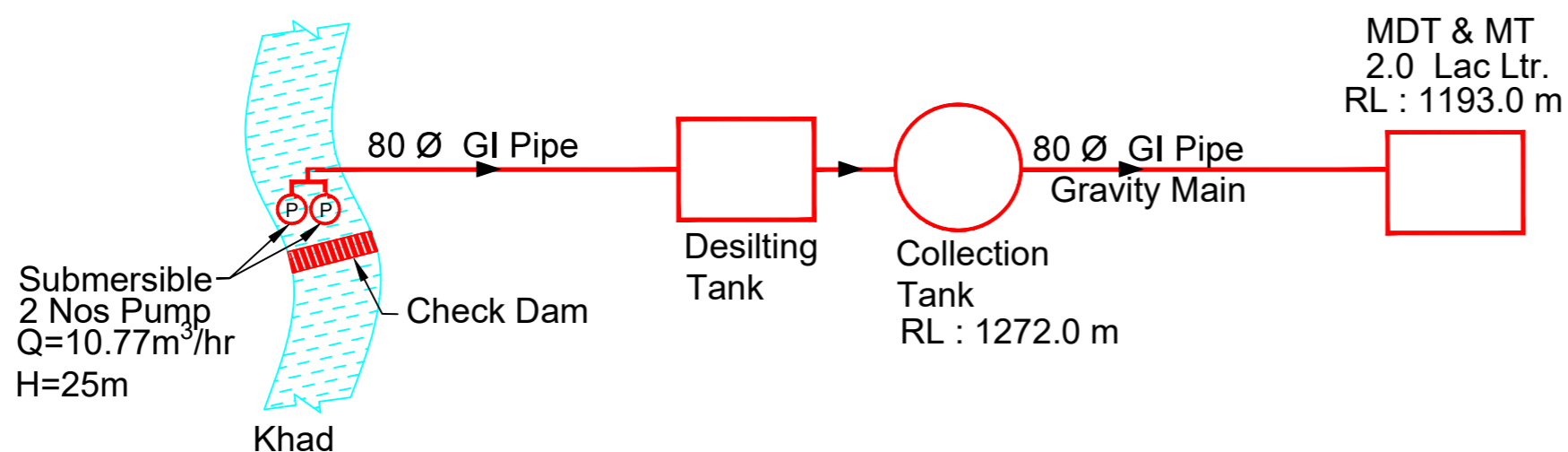

FLOW DIAGRAM – PROPOSED FIS THOUNA KUHAL (NEW SCHEME – 8.18 Ha)

P1	SIGN.										20-07-2022		
	INITIALS	SM	MJ	DVB					MK	DK			
REVISIONS		AS PER CLIENT COMMENTS											
P0	SIGN.										01-06-2022		
	INITIALS	SM	MJ	DVB					MK	DK			
REVISIONS													
ISSUE		DRN	DSN	CHD	CV	EL	IC	ME		PE/PM	APPD	DATE	
					CLEARED								(dd-mm-yyyy)

'P' (PRELIMINARY) ISSUES ARE NOT TO BE USED FOR CONSTRUCTION / FABRICATION BUT ARE ISSUED FOR LIMITED PURPOSES ONLY AS INDICATED IN THE SMALL BLOCK ABOVE THIS BLOCK.

CONSTRUCTION / FABRICATION WORK IS PERMITTED ON 'R' (RELEASED) ISSUES ONLY.

INFORMATION CONTAINED WITHIN 'HOLD' IS NOT RELEASED FOR CONSTRUCTION / FABRICATION. FIELD MUST GET DESIGN OFFICE TO CLEAR 'HOLDS' IN TIME BEFORE PROCEEDING WITH ANY CONSTRUCTION/ FABRICATION WORK RELATED TO 'HOLDS'.

SIGN. OF CLIENT:-

JE	AE	EE	SE

PURPOSE: FOR TENDER ONLY
DO NOT SCALE

Proprietary Notice and Version Control This document contains confidential information for use only by the Client for the Project under consideration, which is provided for the sole purpose of permitting the recipient to evaluate the information submitted herewith, in consideration of receipt of this document unless agreed to in contrary in the Contract; the recipient agrees to maintain such information in confidence and to not reproduce or otherwise disclose this information to any person outside the recipient's organization; except that there is no obligation to maintain the confidentiality of any information which was known to the recipient prior to receipt of such information from Tata Consulting Engineers Limited, or becomes publicly known through no fault of recipient, or Tata Consulting Engineers Limited, or is received without obligation of confidentiality from a third party using no obligation of confidentiality to Tata Consulting Engineers Limited. All information given under this version over rules all and any kind of offers, assumptions, deliberations and contracts submitted verbally (and subsequently communicated in writing) or in writing or otherwise given under any and all previous versions/s.

FILE NAME 12503A-CV-32164-Rev-P1

	DETAILED DESIGN CONSULTANCY, HP-SHIVA (PACKAGE CS09)	
	IRRIGATION, HORTICULTURE, ORCHARDS AND VALUE CHAIN DEVELOPMENT	
FLOW DIAGRAM FOR PROPOSED FIS THOUNA KUHAL GOPALPUR BLOCK MANDI DISTRICT		
	TATA CONSULTING ENGINEERS LIMITED	
	MUMBAI	
SCALE : NTS	DWG NO. TCE.12503A-CV-3082-FD-32164	ISSUE P1
DC & DISC: DEL-CV		

SIZE-A3

LEGEND:

PROPOSED COMPONENT 

SOURCE 

NOTE:

1. ALL PIPE DIAMETERS ARE IN MILLIMETER.
2. RL MAY VARY AS PER ACTUAL ROUTE SURVEY.

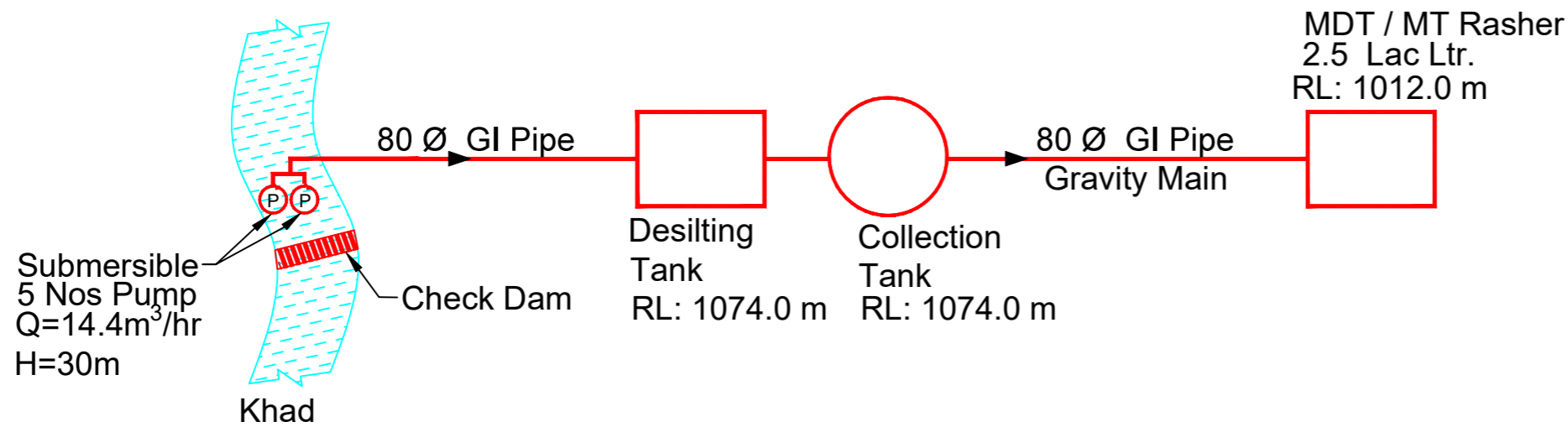

FLOW DIAGRAM – PROPOSED LIS SON KHAD (NEW SCHEME – 10.95 Ha)



P1	SIGN.														
	INITIALS	SM	MJ	DVB								MK	DK	20-07-2022	
	REVISIONS	AS PER CLIENT COMMENTS													
PO	SIGN.														
	INITIALS	SM	MJ	DVB								MK	DK	01-06-2022	
	REVISIONS														
ISSUE		DRN	DSN	CHD	CV	EL	IC	ME			PE/PM	APPD	DATE	(dd-mm-yyyy) CV EL IC ME PE/PM APPD DATE	

'P' (PRELIMINARY) ISSUES ARE NOT TO BE USED FOR CONSTRUCTION / FABRICATION BUT ARE ISSUED FOR LIMITED PURPOSES ONLY AS INDICATED IN THE SMALL BLOCK ABOVE THIS BLOCK.

CONSTRUCTION / FABRICATION WORK IS PERMITTED ON 'R' (RELEASED) ISSUES ONLY.

INFORMATION CONTAINED WITHIN 'HOLD' IS NOT RELEASED FOR CONSTRUCTION / FABRICATION. FIELD MUST GET DESIGN OFFICE TO CLEAR 'HOLDS' IN TIME BEFORE PROCEEDING WITH ANY CONSTRUCTION/ FABRICATION WORK RELATED TO 'HOLDS'.

SIGN. OF CLIENT: -			
JE	AE	EE	SE
PURPOSE: FOR TENDER ONLY			
DO NOT SCALE			
<small>Proprietary Notice and Version Control This document contains confidential information for use only by the Client for the Project under consideration, which is provided for the sole purpose of permitting the recipient to evaluate the information submitted herewith, in consideration of receipt of this document, unless agreed to in contrary in the Contract; the recipient agrees to maintain such information in confidence and to not reproduce or otherwise disclose this information to any person outside the recipient's organization; except that there is no obligation to maintain the confidentiality of any information which was known to the recipient prior to receipt of such information from Tata Consulting Engineers Limited, or becomes publicly known through no fault of recipient, or Tata Consulting Engineers Limited, or is received without obligation of confidentiality from a third party using no obligation of confidentiality to Tata Consulting Engineers Limited. All information given under this version over rides all and any kind of offers, assumptions, observations and contracts submitted verbally (and subsequently communicated in writing) or in writing or otherwise given under any and all previous versions/s.</small>			
FILE NAME		12503A-CV-32165-Rev-P1	

	DETAILED DESIGN CONSULTANCY, HP-SHIVA (PACKAGE CS09) IRRIGATION, HORTICULTURE, ORCHARDS AND VALUE CHAIN DEVELOPMENT	
	FLOW DIAGRAM FOR PROPOSED LIS SON KHAD GOPALPUR BLOCK MANDI DISTRICT	
	TATA CONSULTING ENGINEERS LIMITED MUMBAI	
SCALE : NTS	DWG NO. TCE.12503A-CV-3082-FD-32165	ISSUE P1
DC & DISC: DEL-CV		

LEGEND:

PROPOSED COMPONENT



TUBEWELL

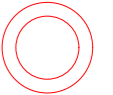

PUMP



NOTE:

- ALL PIPE DIAMETERS ARE IN MILLIMETER.
- RL MAY VARY AS PER ACTUAL ROUTE SURVEY.

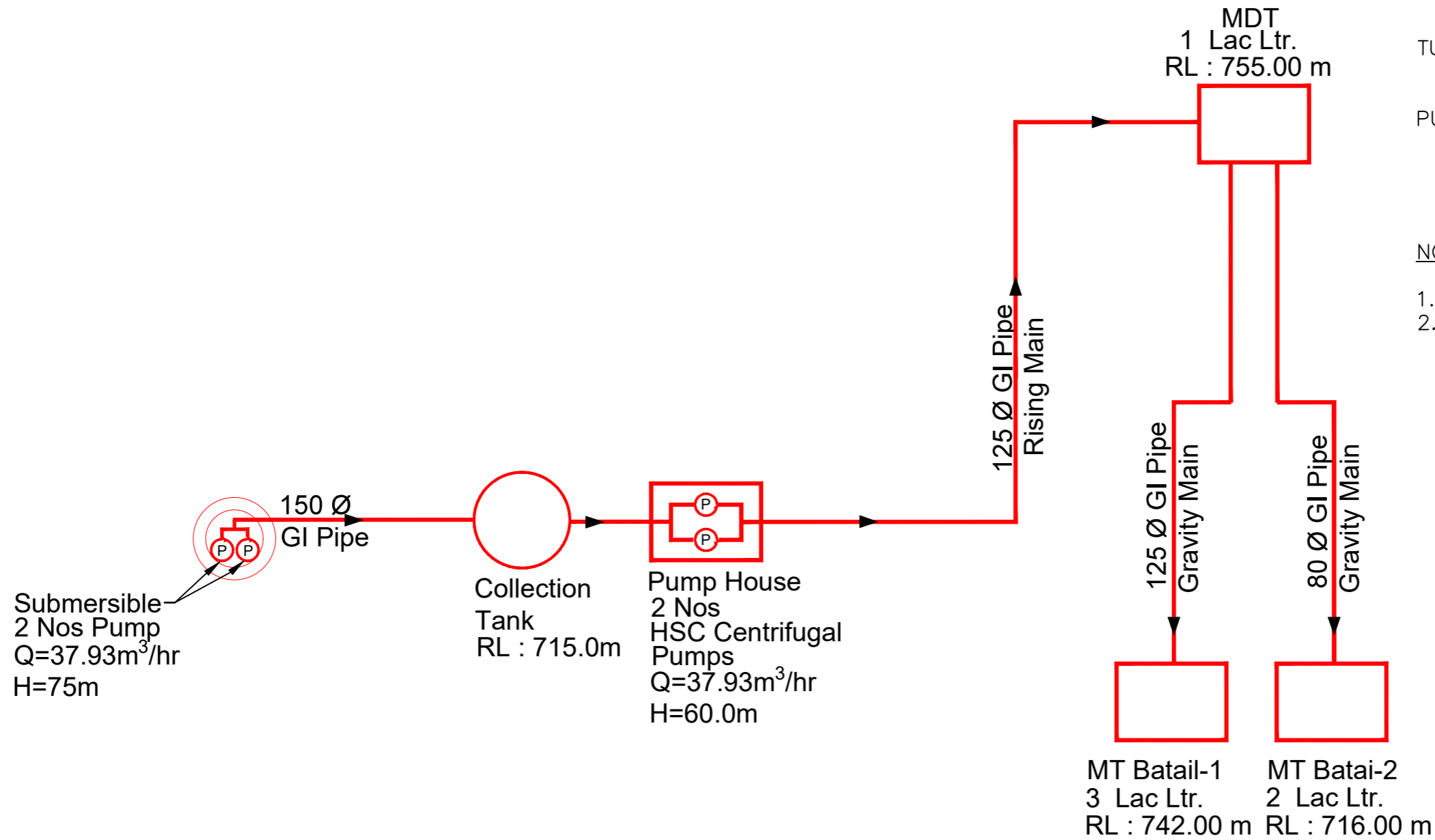



FLOW DIAGRAM – PROPOSED LIS FROM TW-3 (NEW SCHEME – 28.83 Ha)

P1	SIGN.															20-07-2022	'P' (PRELIMINARY) ISSUES ARE NOT TO BE USED FOR CONSTRUCTION / FABRICATION BUT ARE ISSUED FOR LIMITED PURPOSES ONLY AS INDICATED IN THE SMALL BLOCK ABOVE THIS BLOCK.
	INITIALS	SM	MJ	DVB											MK		
P0	SIGN.															01-06-2022	CONSTRUCTION / FABRICATION WORK IS PERMITTED ON 'R' (RELEASED) ISSUES ONLY. INFORMATION CONTAINED WITHIN 'HOLD' IS NOT RELEASED FOR CONSTRUCTION / FABRICATION. FIELD MUST GET DESIGN OFFICE TO CLEAR 'HOLDS' IN TIME BEFORE PROCEEDING WITH ANY CONSTRUCTION/ FABRICATION WORK RELATED TO 'HOLDS'.
	INITIALS	SM	MJ	DVB											MK		
ISSUE		DRN	DSN	CHD	CV	EL	IC	ME		PE/PM	APPD	DATE	CLEARED				(dd-mm-yyyy)

SIGN. OF CLIENT:-			
JE	AE	EE	SE
PURPOSE: FOR TENDER ONLY			
DO NOT SCALE			
<small>Proprietary Notice and Version Control This document contains confidential information for use only by the Client for the Project under consideration, which is provided for the sole purpose of permitting the recipient to evaluate the information submitted herewith. In consideration of receipt of this document, the recipient agrees to maintain such information in confidence and to not reproduce or otherwise disclose this information to any person outside the recipient's organization, except that there is no obligation to maintain the confidentiality of any information which was known to the recipient prior to receipt of such information from Tata Consulting Engineers Limited, or becomes publicly known through no fault of recipient, or Tata Consulting Engineers Limited, or is received without obligation of confidentiality from a third party using no obligation of confidentiality to Tata Consulting Engineers Limited. All information given under this version over rides all and any kind of offers, assumptions, deliberations and contracts submitted verbally (and subsequently communicated in writing) or in writing or otherwise given under any and all previous versions/s.</small>			
FILE NAME		12503A-CV-32166-Rev-P1	

	DETAILED DESIGN CONSULTANCY, HP-SHIVA (PACKAGE CS09) IRRIGATION, HORTICULTURE, ORCHARDS AND VALUE CHAIN DEVELOPMENT
	FLOW DIAGRAM FOR PROPOSED LIS FROM TW-3 GOPALPUR BLOCK MANDI DISTRICT
	TATA CONSULTING ENGINEERS LIMITED MUMBAI
SCALE : NTS	DWG NO. TCE.12503A-CV-3082-FD-32166
DC & DISC: DEL-CV	ISSUE P1

LEGEND:

- PROPOSED COMPONENT 
- TUBEWELL 
- PUMP 

NOTE:

1. ALL PIPE DIAMETERS ARE IN MILLIMETER.
2. RL MAY VARY AS PER ACTUAL ROUTE SURVEY.

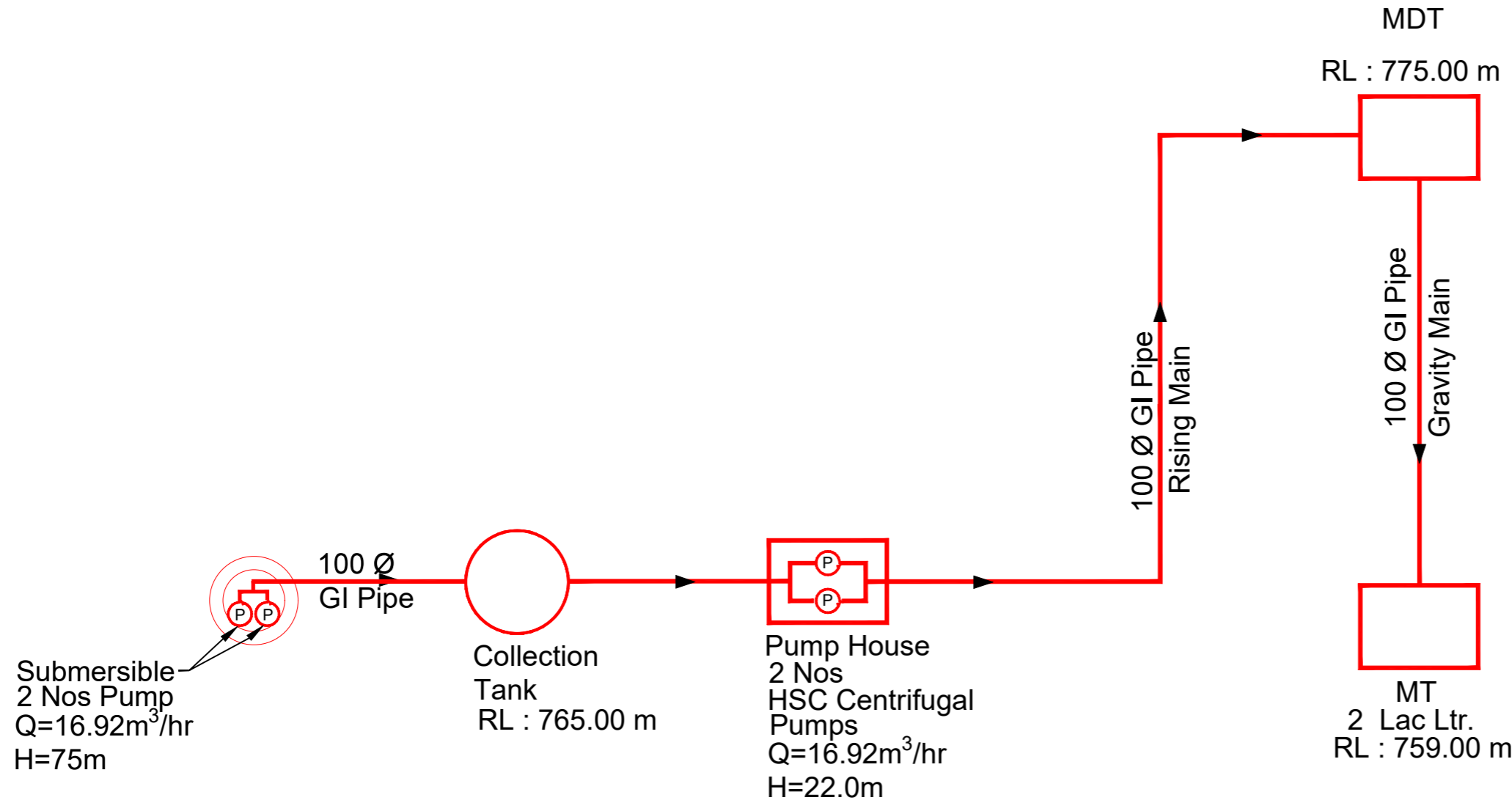

FLOW DIAGRAM – PROPOSED LIS FROM TW-4 (NEW SCHEME – 12.86 Ha)



P1	SIGN.																	20-07-2022
	INITIALS	SM	MJ	DVB										MK	DK			
REVISIONS		AS PER CLIENT COMMENTS																
PO	SIGN.																	01-06-2022
	INITIALS	SM	MJ	DVB										MK	DK			
REVISIONS																		
ISSUE		DRN	DSN	CHD	CV	EL	IC	ME			PE/PM	APPD	DATE					
													CLEARED					

'P' (PRELIMINARY) ISSUES ARE NOT TO BE USED FOR CONSTRUCTION / FABRICATION BUT ARE ISSUED FOR LIMITED PURPOSES ONLY AS INDICATED IN THE SMALL BLOCK ABOVE THIS BLOCK.

CONSTRUCTION / FABRICATION WORK IS PERMITTED ON 'R' (RELEASED) ISSUES ONLY.

INFORMATION CONTAINED WITHIN 'HOLD' IS NOT RELEASED FOR CONSTRUCTION / FABRICATION. FIELD MUST GET DESIGN OFFICE TO CLEAR 'HOLDS' IN TIME BEFORE PROCEEDING WITH ANY CONSTRUCTION/ FABRICATION WORK RELATED TO 'HOLDS'.

SIGN. OF CLIENT:-			
JE	AE	EE	SE
PURPOSE: FOR TENDER ONLY			
DO NOT SCALE			
<small>Proprietary Notice and Version Control This document contains confidential information for use only by the Client for the Project under consideration, which is provided for the sole purpose of permitting the recipient to evaluate the information submitted herewith. In consideration of receipt of this document, unless agreed to in contrary in the Contract, the recipient agrees to maintain such information in confidence and to not reproduce or otherwise disclose this information to any person outside the recipient's organization except that there is no obligation to maintain the confidentiality of any information which was known to the recipient prior to receipt of such information from Tata Consulting Engineers Limited, or becomes publicly known through no fault of recipient, or Tata Consulting Engineers Limited, or is received without obligation of confidentiality from a third party using no obligation of confidentiality to Tata Consulting Engineers Limited. All information given under this version over rides all and any kind of offers, assumptions, deliveries and contracts submitted verbally (and subsequently communicated in writing) or in writing or otherwise given under any and all previous versions/s.</small>			
FILE NAME 12503A-CV-32167-Rev-P1			

	DETAILED DESIGN CONSULTANCY, HP-SHIVA (PACKAGE CS09) IRRIGATION, HORTICULTURE, ORCHARDS AND VALUE CHAIN DEVELOPMENT
FLOW DIAGRAM FOR PROPOSED LIS FROM TW-4 GOPALPUR BLOCK MANDI DISTRICT	
	TATA CONSULTING ENGINEERS LIMITED MUMBAI
SCALE : NTS	DWG NO. TCE.12503A-CV-3082-FD-32167
DC & DISC: DEL-CV	ISSUE P1

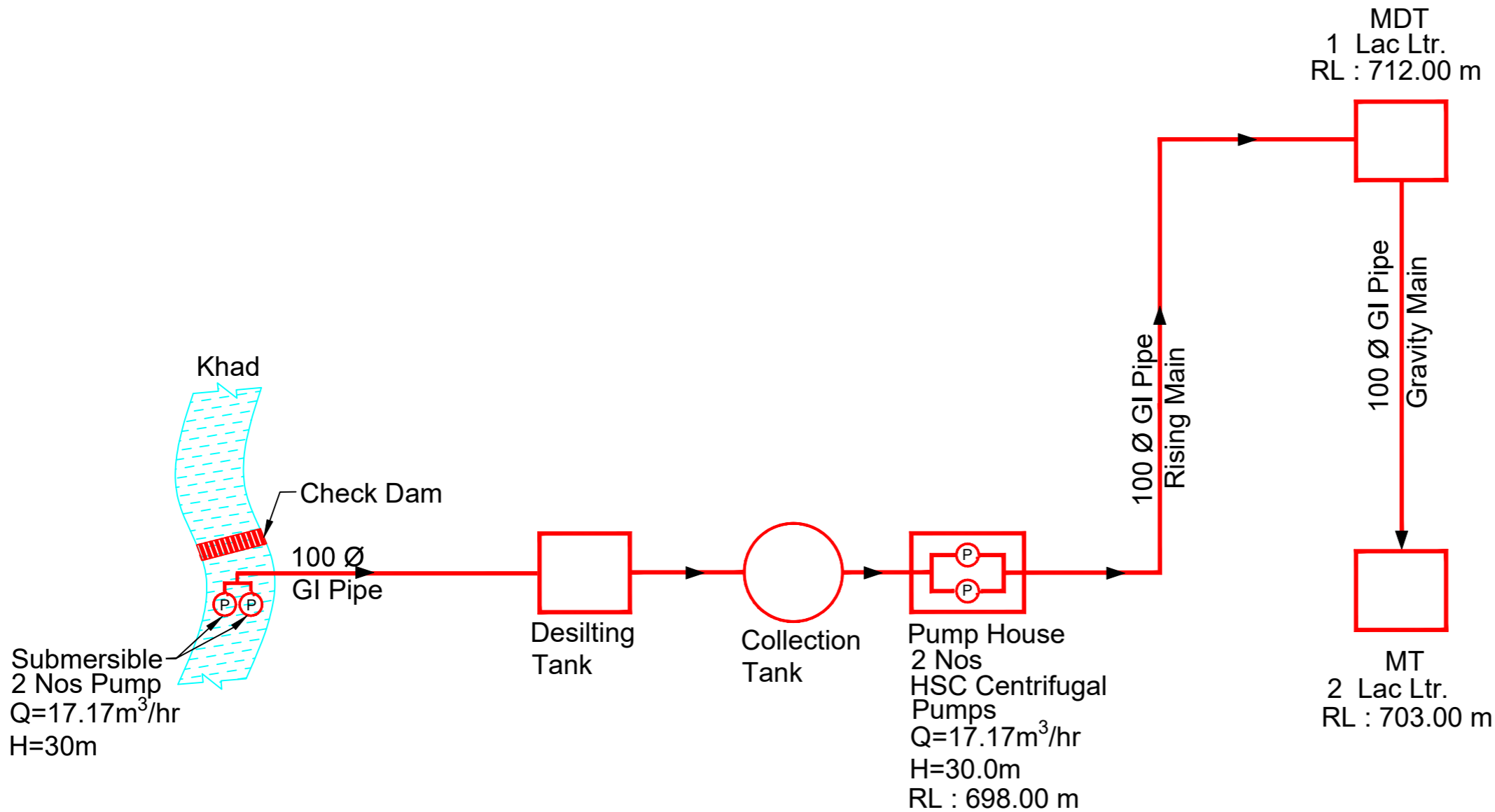

LEGEND:

- PROPOSED COMPONENT
- SOURCE
- PUMP



NOTE:

1. ALL PIPE DIAMETERS ARE IN MILLIMETER.
2. RL MAY VARY AS PER ACTUAL ROUTE SURVEY.

FLOW DIAGRAM – PROPOSED LIS INFILTRATION–SEER KHAD (NEW SCHEME – 13.05 Hd)

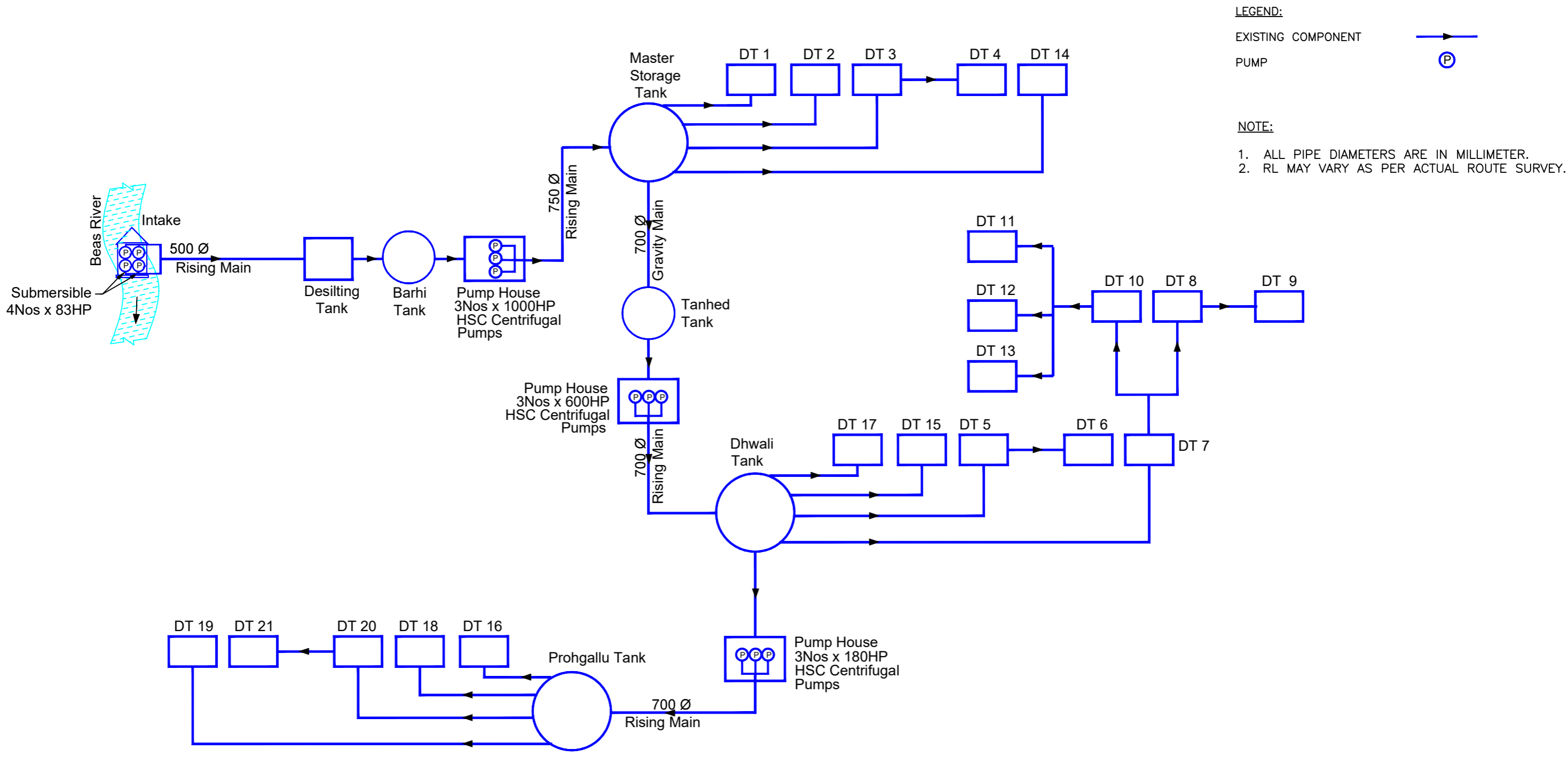
<table border="1" style="width: 100%; border-collapse: collapse;"> <tr> <td style="width: 5%;">SIGN.</td> <td></td><td></td><td></td><td></td><td></td><td></td><td></td><td></td><td></td><td></td><td></td> </tr> <tr> <td>INITIALS</td> <td>SM</td><td>MJ</td><td>DVB</td><td></td><td></td><td></td><td></td><td></td><td>MK</td><td>DK</td><td>20-07-2022</td> </tr> <tr> <td>REVISIONS</td> <td colspan="11">AS PER CLIENT COMMENTS</td> </tr> <tr> <td>SIGN.</td> <td></td><td></td><td></td><td></td><td></td><td></td><td></td><td></td><td></td><td></td><td></td> </tr> <tr> <td>INITIALS</td> <td>SM</td><td>MJ</td><td>DVB</td><td></td><td></td><td></td><td></td><td></td><td>MK</td><td>DK</td><td>01-06-2022</td> </tr> <tr> <td>REVISIONS</td> <td colspan="11"></td> </tr> <tr> <td>ISSUE</td> <td>DRN</td><td>DSN</td><td>CHD</td><td>CV</td><td>EL</td><td>IC</td><td>ME</td><td></td><td>PE/PM</td><td>APPD</td><td>DATE (dd-mm-yyyy)</td> </tr> <tr> <td></td> <td></td><td></td><td></td><td>CLEARED</td><td></td><td></td><td></td><td></td><td></td><td></td><td></td> </tr> </table>												SIGN.												INITIALS	SM	MJ	DVB						MK	DK	20-07-2022	REVISIONS	AS PER CLIENT COMMENTS											SIGN.												INITIALS	SM	MJ	DVB						MK	DK	01-06-2022	REVISIONS												ISSUE	DRN	DSN	CHD	CV	EL	IC	ME		PE/PM	APPD	DATE (dd-mm-yyyy)					CLEARED								<p>PROPRIETARY NOTICE: 'P' (PRELIMINARY) ISSUES ARE NOT TO BE USED FOR CONSTRUCTION / FABRICATION BUT ARE ISSUED FOR LIMITED PURPOSES ONLY AS INDICATED IN THE SMALL BLOCK ABOVE THIS BLOCK.</p> <p>CONSTRUCTION / FABRICATION WORK IS PERMITTED ON 'R' (RELEASED) ISSUES ONLY.</p> <p>INFORMATION CONTAINED WITHIN 'HOLD' IS NOT RELEASED FOR CONSTRUCTION / FABRICATION. FIELD MUST GET DESIGN OFFICE TO CLEAR 'HOLDS' IN TIME BEFORE PROCEEDING WITH ANY CONSTRUCTION/ FABRICATION WORK RELATED TO 'HOLDS'.</p>											
												SIGN.																																																																																																											
INITIALS	SM	MJ	DVB						MK	DK	20-07-2022																																																																																																												
REVISIONS	AS PER CLIENT COMMENTS																																																																																																																						
SIGN.																																																																																																																							
INITIALS	SM	MJ	DVB						MK	DK	01-06-2022																																																																																																												
REVISIONS																																																																																																																							
ISSUE	DRN	DSN	CHD	CV	EL	IC	ME		PE/PM	APPD	DATE (dd-mm-yyyy)																																																																																																												
				CLEARED																																																																																																																			
<p>FILE NAME: F-093-Rev-R1.DWG</p>												<p>SIGN. OF CLIENT:–</p> <table border="1" style="width: 100%; border-collapse: collapse;"> <tr> <td style="width: 25%; height: 30px;"></td> <td style="width: 25%;"></td> <td style="width: 25%;"></td> <td style="width: 25%;"></td> </tr> <tr> <td style="text-align: center;">JE</td> <td style="text-align: center;">AE</td> <td style="text-align: center;">EE</td> <td style="text-align: center;">SE</td> </tr> </table> <p>PURPOSE: FOR TENDER ONLY</p> <p>DO NOT SCALE</p>								JE	AE	EE	SE	<p>DETAILED DESIGN CONSULTANCY, HP–SHIVA (PACKAGE CS09) IRRIGATION, HORTICULTURE, ORCHARDS AND VALUE CHAIN DEVELOPMENT</p>				<p>FLOW DIAGRAM FOR PROPOSED LIS INFILTRATION–SEER KHAD GOPALPUR BLOCK MANDI DISTRICT</p>				<p>TATA CONSULTING ENGINEERS LIMITED MUMBAI</p>																																																																																							
JE	AE	EE	SE																																																																																																																				
<p>SCALE : NTS</p>												<p>DWG NO. TCE.12503A–CV–3082–FD–32168</p>				<p>ISSUE P1</p>																																																																																																							
<p>DC & DISC: DEL–CV</p>												<p>FILE NAME 12503A–CV–32168–Rev–P1</p>				<p>TCE FORM NO. 093 R1</p>																																																																																																							



LEGEND:
 EXISTING COMPONENT 
 PUMP 

NOTE:
 1. ALL PIPE DIAMETERS ARE IN MILLIMETER.
 2. RL MAY VARY AS PER ACTUAL ROUTE SURVEY.

FLOW DIAGRAM – EXISTING LIS BARHI, MARHI, DHWALI (FUNCTIONAL SCHEME)

P1	SIGN.											
	INITIALS	SM	MJ	DVB					MK	DK	20-07-2022	
REVISIONS		AS PER CLIENT COMMENTS										
P0	SIGN.											
	INITIALS	SM	MJ	DVB					MK	DK	01-06-2022	
REVISIONS												
ISSUE	DRN	DSN	CHD	CV	EL	IC	ME		PE/PM	APPD	DATE	
					CLEARED						(dd-mm-yyyy)	

'P' (PRELIMINARY) ISSUES ARE NOT TO BE USED FOR CONSTRUCTION / FABRICATION BUT ARE ISSUED FOR LIMITED PURPOSES ONLY AS INDICATED IN THE SMALL BLOCK ABOVE THIS BLOCK.

CONSTRUCTION / FABRICATION WORK IS PERMITTED ON 'R' (RELEASED) ISSUES ONLY.

INFORMATION CONTAINED WITHIN 'HOLD' IS NOT RELEASED FOR CONSTRUCTION / FABRICATION. FIELD MUST GET DESIGN OFFICE TO CLEAR 'HOLDS' IN TIME BEFORE PROCEEDING WITH ANY CONSTRUCTION/ FABRICATION WORK RELATED TO 'HOLDS'.

SIGN. OF CLIENT:—

JE	AE	EE	SE
----	----	----	----

PURPOSE: FOR TENDER ONLY

DO NOT SCALE

Proprietary Notice and Version Control: This document contains confidential information for use only by the Client. For the Project under consideration, which is provided for the sole purpose of permitting the recipient to evaluate the information submitted herewith, in consideration of receipt of this document, unless agreed to in contrary in the Contract, the recipient agrees to maintain such information in confidence and to not reproduce or otherwise disclose this information to any person outside the recipient's organization, except that there is no obligation to maintain the confidentiality of any information which was known to the recipient prior to receipt of such information from Tata Consulting Engineers Limited, or becomes publicly known through no fault of recipient, or Tata Consulting Engineers Limited, or is received without obligation of confidentiality from a third party owing no obligation of confidentiality to Tata Consulting Engineers Limited. All information given under this version over rides all and any kind of offers, assumptions, deliberations and contracts submitted verbally (and subsequently communicated in writing) or in writing or otherwise given under any and all previous version/s.

FILE NAME: 12503A-CV-32169-Rev-P1

 DETAILED DESIGN CONSULTANCY, HP-SHIVA (PACKAGE CS09)
 IRRIGATION, HORTICULTURE, ORCHARDS AND VALUE CHAIN DEVELOPMENT

FLOW DIAGRAM FOR EXISTING LIS BARHI, MARHI, DHWALI
 DHARAMPUR BLOCK MANDI DISTRICT

 **TATA CONSULTING ENGINEERS LIMITED**
 MUMBAI

SCALE : NTS	DWG NO. TCE.12503A-CV-3082-FD-32169	ISSUE P1
DC & DISC: DEL-CV		

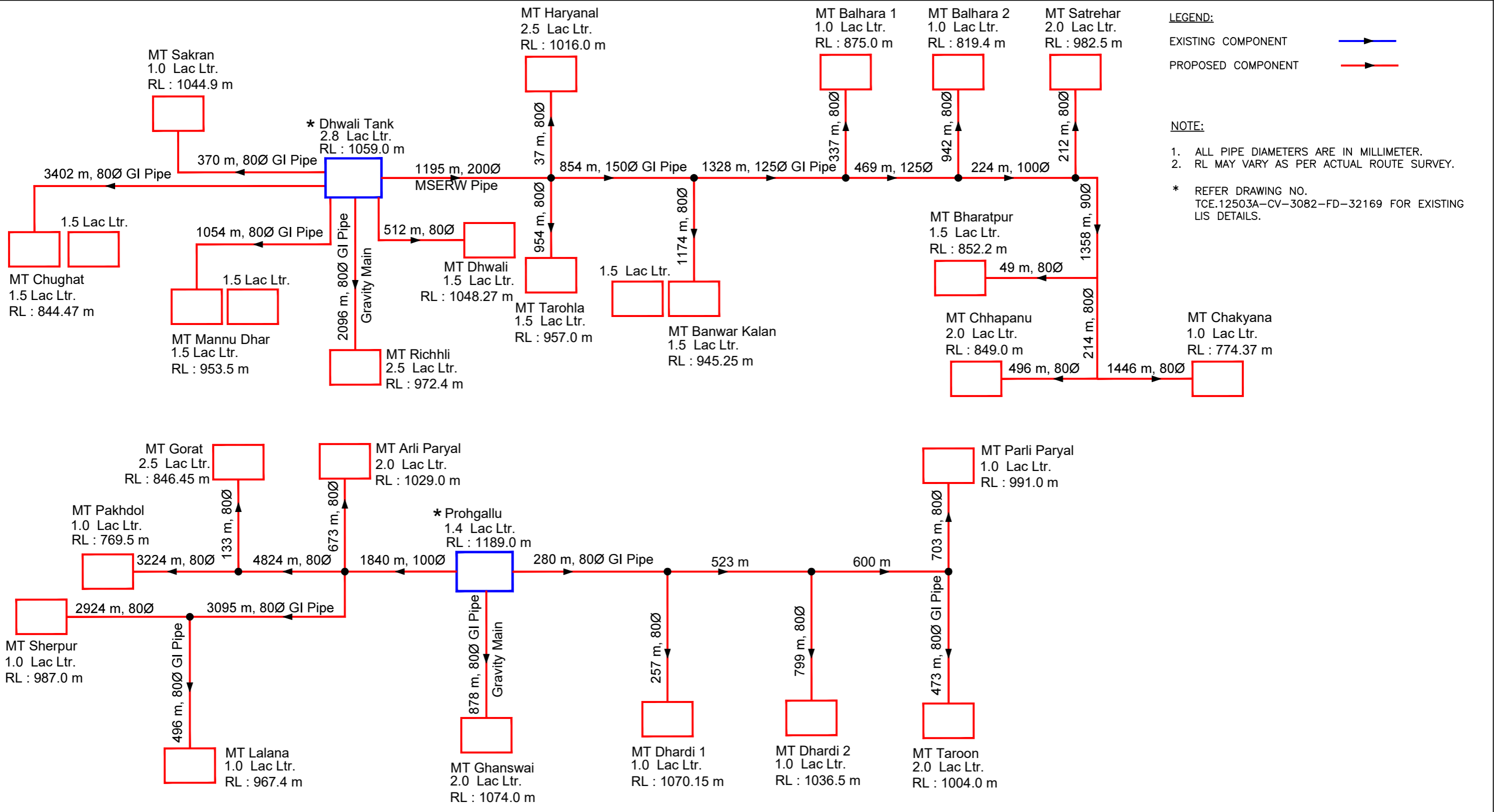

LEGEND:
 EXISTING COMPONENT →
 PROPOSED COMPONENT →

NOTE:
 1. ALL PIPE DIAMETERS ARE IN MILLIMETER.
 2. RL MAY VARY AS PER ACTUAL ROUTE SURVEY.

* REFER DRAWING NO. TCE.12503A-CV-3082-FD-32169 FOR EXISTING LIS DETAILS.

FLOW DIAGRAM – PROPOSED LIS BARHI, MARHI, DHWALI (FUNCTIONAL SCHEME– 178.97 Ha)

P1	SIGN.											
	INITIALS	SM	MJ	DVB					MK	DK	20-07-2022	
REVISIONS		AS PER CLIENT COMMENTS										
P0	SIGN.											
	INITIALS	SM	MJ	DVB					MK	DK	01-06-2022	
REVISIONS												
ISSUE		DRN	DSN	CHD	CV	EL	IC	ME		PE/PM	APPD	DATE
												(dd-mm-yyyy)
					CLEARED							

'P' (PRELIMINARY) ISSUES ARE NOT TO BE USED FOR CONSTRUCTION / FABRICATION BUT ARE ISSUED FOR LIMITED PURPOSES ONLY AS INDICATED IN THE SMALL BLOCK ABOVE THIS BLOCK.

CONSTRUCTION / FABRICATION WORK IS PERMITTED ON 'R' (RELEASED) ISSUES ONLY.

INFORMATION CONTAINED WITHIN 'HOLD' IS NOT RELEASED FOR CONSTRUCTION / FABRICATION. FIELD MUST GET DESIGN OFFICE TO CLEAR 'HOLDS' IN TIME BEFORE PROCEEDING WITH ANY CONSTRUCTION/ FABRICATION WORK RELATED TO 'HOLDS'.

SIGN. OF CLIENT:-

JE	AE	EE	SE
----	----	----	----

PURPOSE: FOR TENDER ONLY

DO NOT SCALE

Proprietary Notice and Version Control This document contains confidential information for use only by the Client for the Project under consideration, which is provided for the sole purpose of permitting the recipient to evaluate the information submitted herewith, in consideration of receipt of this document, unless agreed to in contrary in the Contract; the recipient agrees to maintain such information in confidence and to not reproduce or otherwise disclose this information to any person outside the recipient's organization; except that there is no obligation to maintain the confidentiality of any information which was known to the recipient prior to receipt of such information from Tata Consulting Engineers Limited, or becomes publicly known through no fault of recipient, or Tata Consulting Engineers Limited, or is received without obligation of confidentiality from a third party using no obligation of confidentiality to Tata Consulting Engineers Limited. All information given under this version over rides all and any kind of offers, assumptions, deliberations and contracts submitted verbally (and subsequently communicated in writing) or in writing or otherwise given under any and all previous versions/.

FILE NAME 12503A-CV-32170-Rev-P1

DETAILED DESIGN CONSULTANCY, HP-SHIVA (PACKAGE CS09)
 IRRIGATION, HORTICULTURE, ORCHARDS AND VALUE CHAIN DEVELOPMENT

FLOW DIAGRAM FOR PROPOSED LIS BARHI, MARHI, DHWALI
 DHARAMPUR BLOCK MANDI DISTRICT

SCALE : NTS DWG NO. TCE.12503A-CV-3082-FD-32170 ISSUE P1

DC & DISC: DEL-CV

LEGEND:

EXISTING COMPONENT



SOURCE



PUMP



NOTE:

1. ALL PIPE DIAMETERS ARE IN MILLIMETER.
2. RL MAY VARY AS PER ACTUAL ROUTE SURVEY.

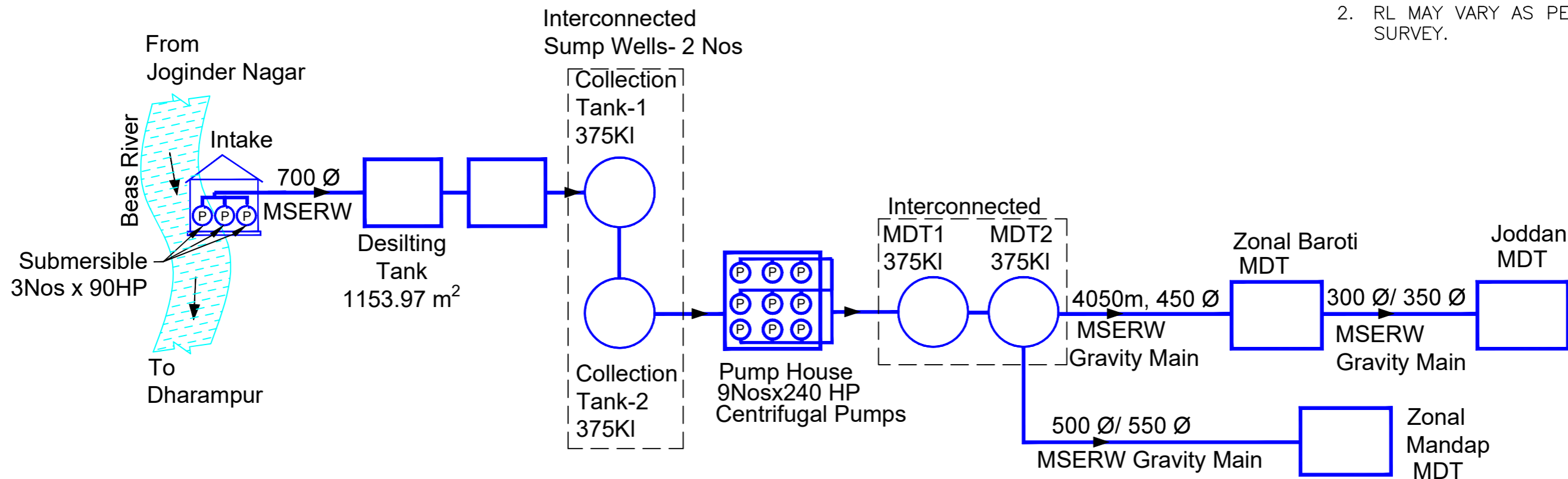

FLOW DIAGRAM – EXISTING LIS BAROTI, MANDAP, JODDAN
(FUNCTIONAL SCHEME)

DETAILED DESIGN CONSULTANCY, HP-SHIVA (PACKAGE CS09)
IRRIGATION, HORTICULTURE, ORCHARDS AND VALUE CHAIN DEVELOPMENT

FLOW DIAGRAM FOR EXISTING LIS BAROTI, MANDAP, JODDAN
DHARAMPUR BLOCK MANDI DISTRICT

SIGN. OF CLIENT:-

JE	AE	EE	SE
----	----	----	----

PURPOSE: FOR TENDER ONLY

DO NOT SCALE

Proprietary Notice and Version Control This document contains confidential information for use only by the Client. For the Project under consideration, which is provided for the sole purpose of permitting the recipient to evaluate the information submitted hereon, in consideration of receipt of this document, unless agreed to in contrary in the Contract, the recipient agrees to maintain such information in confidence and to not reproduce or otherwise disclose this information to any person outside the recipient's organization; except that there is no obligation to maintain the confidentiality of any information which was known to the recipient prior to receipt of such information from Tata Consulting Engineers Limited, or becomes publicly known through no fault of recipient, or Tata Consulting Engineers Limited, or is received without obligation of confidentiality from a third party using no obligation of confidentiality to Tata Consulting Engineers Limited. All information given under this version over time and any kind of offers, conceptions, deliberations and contracts submitted verbally (and subsequently communicated in writing) or in writing or otherwise given under any and all previous versions/versions (and subsequently communicated in writing) or in writing or otherwise given under any and all previous versions/versions.

TATA CONSULTING ENGINEERS LIMITED
MUMBAI

SIGN.											
	INITIALS										
	REVISIONS										
PO	SIGN.										
	SM	MJ	DVB					MK	DK	01-06-2022	
	REVISIONS										
ISSUE	DRN	DSN	CHD	CV	EL	IC	ME		PE/PM	APPD	DATE
	CLEARED										

'P' (PRELIMINARY) ISSUES ARE NOT TO BE USED FOR CONSTRUCTION / FABRICATION BUT ARE ISSUED FOR LIMITED PURPOSES ONLY AS INDICATED IN THE SMALL BLOCK ABOVE THIS BLOCK.

CONSTRUCTION / FABRICATION WORK IS PERMITTED ON 'R' (RELEASED) ISSUES ONLY.

INFORMATION CONTAINED WITHIN 'HOLD' IS NOT RELEASED FOR CONSTRUCTION / FABRICATION. FIELD MUST GET DESIGN OFFICE TO CLEAR 'HOLDS' IN TIME BEFORE PROCEEDING WITH ANY CONSTRUCTION/ FABRICATION WORK RELATED TO 'HOLDS'.

SCALE : NTS	DWG NO. TCE.12503A-CV-3082-FD-32171	ISSUE PO
FILE NAME 12503A-CV-32171-Rev-P0	DC & DISC: DEL-CV	

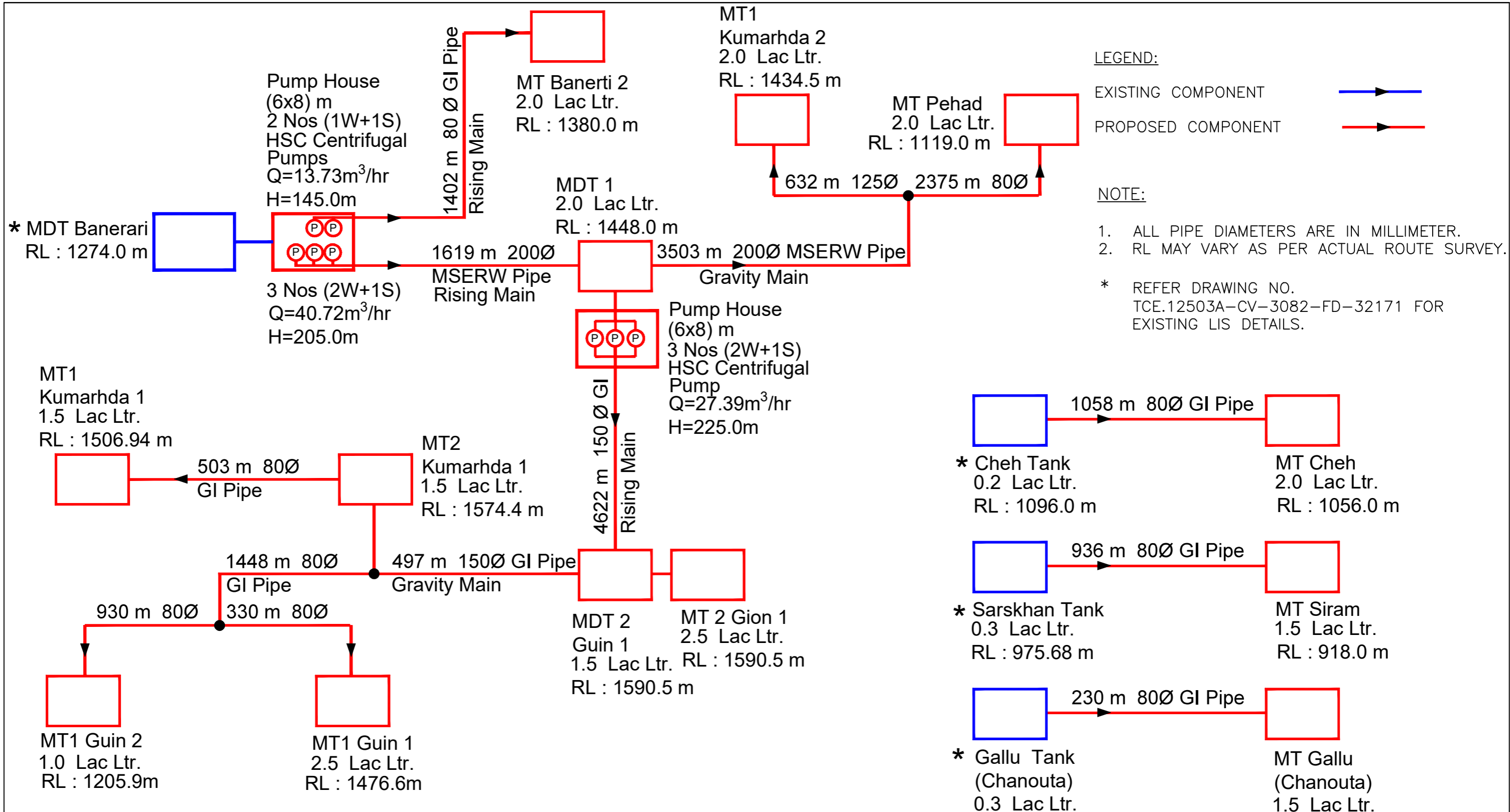

FLOW DIAGRAM – PROPOSED LIS BAROTI, MANDAP & JODDHAN (NEW SCHEME – 152.16 Ha)

DETAILED DESIGN CONSULTANCY, HP-SHIVA (PACKAGE CS09) IRRIGATION, HORTICULTURE, ORCHARDS AND VALUE CHAIN DEVELOPMENT																																																																																								
SIGN. OF CLIENT:— <table border="1" style="width: 100%; height: 40px;"> <tr> <td style="width: 25%;"></td> <td style="width: 25%;"></td> <td style="width: 25%;"></td> <td style="width: 25%;"></td> </tr> <tr> <td style="text-align: center;">JE</td> <td style="text-align: center;">AE</td> <td style="text-align: center;">EE</td> <td style="text-align: center;">SE</td> </tr> </table>														JE	AE	EE	SE																																																																							
JE	AE	EE	SE																																																																																					
FLOW DIAGRAM FOR PROPOSED LIS BAROTI, MANDAP & JODDHAN DHARAMPUR BLOCK MANDI DISTRICT																																																																																								
PURPOSE: FOR TENDER ONLY DO NOT SCALE																																																																																								
<table border="1" style="width: 100%; font-size: small;"> <tr> <td colspan="10"> PROPRIETARY NOTICE AND VERSION CONTROL: This document contains confidential information for use only by the Client. For the Project under consideration, which is provided for the sole purpose of permitting the recipient to evaluate the information submitted herewith, in consideration of receipt of this document, the recipient agrees to maintain such information in confidence and to not reproduce or otherwise disclose this information to any person outside the recipient's organization, except that there is no obligation to maintain the confidentiality of any information which was known to the recipient prior to receipt of such information from Tata Consulting Engineers Limited, or becomes publicly known through no fault of recipient, or Tata Consulting Engineers Limited, or is received without obligation of confidentiality from a third party owing no obligation of confidentiality to Tata Consulting Engineers Limited. All information given under this version over rides all and any kind of offers, assumptions, deliberations and contracts submitted verbally (and subsequently communicated in writing) or in writing or otherwise given under any and all previous versions/s. </td> </tr> <tr> <td colspan="5"> TATA CONSULTING ENGINEERS LIMITED MUMBAI </td> <td colspan="5"> SCALE : NTS DWG NO. TCE.12503A-CV-3082-FD-32172 DC & DISC: DEL-CV </td> </tr> </table>										PROPRIETARY NOTICE AND VERSION CONTROL: This document contains confidential information for use only by the Client. For the Project under consideration, which is provided for the sole purpose of permitting the recipient to evaluate the information submitted herewith, in consideration of receipt of this document, the recipient agrees to maintain such information in confidence and to not reproduce or otherwise disclose this information to any person outside the recipient's organization, except that there is no obligation to maintain the confidentiality of any information which was known to the recipient prior to receipt of such information from Tata Consulting Engineers Limited, or becomes publicly known through no fault of recipient, or Tata Consulting Engineers Limited, or is received without obligation of confidentiality from a third party owing no obligation of confidentiality to Tata Consulting Engineers Limited. All information given under this version over rides all and any kind of offers, assumptions, deliberations and contracts submitted verbally (and subsequently communicated in writing) or in writing or otherwise given under any and all previous versions/s.										TATA CONSULTING ENGINEERS LIMITED MUMBAI					SCALE : NTS DWG NO. TCE.12503A-CV-3082-FD-32172 DC & DISC: DEL-CV																																																															
PROPRIETARY NOTICE AND VERSION CONTROL: This document contains confidential information for use only by the Client. For the Project under consideration, which is provided for the sole purpose of permitting the recipient to evaluate the information submitted herewith, in consideration of receipt of this document, the recipient agrees to maintain such information in confidence and to not reproduce or otherwise disclose this information to any person outside the recipient's organization, except that there is no obligation to maintain the confidentiality of any information which was known to the recipient prior to receipt of such information from Tata Consulting Engineers Limited, or becomes publicly known through no fault of recipient, or Tata Consulting Engineers Limited, or is received without obligation of confidentiality from a third party owing no obligation of confidentiality to Tata Consulting Engineers Limited. All information given under this version over rides all and any kind of offers, assumptions, deliberations and contracts submitted verbally (and subsequently communicated in writing) or in writing or otherwise given under any and all previous versions/s.																																																																																								
TATA CONSULTING ENGINEERS LIMITED MUMBAI					SCALE : NTS DWG NO. TCE.12503A-CV-3082-FD-32172 DC & DISC: DEL-CV																																																																																			
<table border="1" style="width: 100%; font-size: x-small;"> <tr> <td rowspan="2">P1</td> <td>SIGN.</td> <td></td><td></td><td></td><td></td><td></td><td></td><td></td><td></td> <td rowspan="2">20-07-2022</td> <td rowspan="2"> 'P' (PRELIMINARY) ISSUES ARE NOT TO BE USED FOR CONSTRUCTION / FABRICATION BUT ARE ISSUED FOR LIMITED PURPOSES ONLY AS INDICATED IN THE SMALL BLOCK ABOVE THIS BLOCK. </td> </tr> <tr> <td>INITIALS</td> <td>SM</td><td>MJ</td><td>DVB</td><td></td><td></td><td></td><td></td><td>MK</td><td>DK</td> </tr> <tr> <td colspan="11">REVISIONS AS PER CLIENT COMMENTS</td> </tr> <tr> <td rowspan="2">P0</td> <td>SIGN.</td> <td></td><td></td><td></td><td></td><td></td><td></td><td></td><td></td> <td rowspan="2">01-06-2022</td> <td rowspan="2"> CONSTRUCTION / FABRICATION WORK IS PERMITTED ON 'R' (RELEASED) ISSUES ONLY. </td> </tr> <tr> <td>INITIALS</td> <td>SM</td><td>MJ</td><td>DVB</td><td></td><td></td><td></td><td></td><td>MK</td><td>DK</td> </tr> <tr> <td colspan="11">REVISIONS</td> </tr> <tr> <td>ISSUE</td> <td>DRN</td> <td>DSN</td> <td>CHD</td> <td>CV</td> <td>EL</td> <td>IC</td> <td>ME</td> <td></td> <td>PE/PM</td> <td>APPD</td> <td>DATE (dd-mm-yyyy)</td> <td> INFORMATION CONTAINED WITHIN 'HOLD' IS NOT RELEASED FOR CONSTRUCTION / FABRICATION. FIELD MUST GET DESIGN OFFICE TO CLEAR 'HOLDS' IN TIME BEFORE PROCEEDING WITH ANY CONSTRUCTION/ FABRICATION WORK RELATED TO 'HOLDS'. </td> </tr> </table>										P1	SIGN.									20-07-2022	'P' (PRELIMINARY) ISSUES ARE NOT TO BE USED FOR CONSTRUCTION / FABRICATION BUT ARE ISSUED FOR LIMITED PURPOSES ONLY AS INDICATED IN THE SMALL BLOCK ABOVE THIS BLOCK.	INITIALS	SM	MJ	DVB					MK	DK	REVISIONS AS PER CLIENT COMMENTS											P0	SIGN.									01-06-2022	CONSTRUCTION / FABRICATION WORK IS PERMITTED ON 'R' (RELEASED) ISSUES ONLY.	INITIALS	SM	MJ	DVB					MK	DK	REVISIONS											ISSUE	DRN	DSN	CHD	CV	EL	IC	ME		PE/PM	APPD	DATE (dd-mm-yyyy)	INFORMATION CONTAINED WITHIN 'HOLD' IS NOT RELEASED FOR CONSTRUCTION / FABRICATION. FIELD MUST GET DESIGN OFFICE TO CLEAR 'HOLDS' IN TIME BEFORE PROCEEDING WITH ANY CONSTRUCTION/ FABRICATION WORK RELATED TO 'HOLDS'.
P1	SIGN.										20-07-2022	'P' (PRELIMINARY) ISSUES ARE NOT TO BE USED FOR CONSTRUCTION / FABRICATION BUT ARE ISSUED FOR LIMITED PURPOSES ONLY AS INDICATED IN THE SMALL BLOCK ABOVE THIS BLOCK.																																																																												
	INITIALS	SM	MJ	DVB					MK	DK																																																																														
REVISIONS AS PER CLIENT COMMENTS																																																																																								
P0	SIGN.									01-06-2022	CONSTRUCTION / FABRICATION WORK IS PERMITTED ON 'R' (RELEASED) ISSUES ONLY.																																																																													
	INITIALS	SM	MJ	DVB					MK			DK																																																																												
REVISIONS																																																																																								
ISSUE	DRN	DSN	CHD	CV	EL	IC	ME		PE/PM	APPD	DATE (dd-mm-yyyy)	INFORMATION CONTAINED WITHIN 'HOLD' IS NOT RELEASED FOR CONSTRUCTION / FABRICATION. FIELD MUST GET DESIGN OFFICE TO CLEAR 'HOLDS' IN TIME BEFORE PROCEEDING WITH ANY CONSTRUCTION/ FABRICATION WORK RELATED TO 'HOLDS'.																																																																												

LEGEND:

EXISTING COMPONENT 

SOURCE 

PUMP 

NOTE:

1. ALL PIPE DIAMETERS ARE IN MILLIMETER.
2. RL MAY VARY AS PER ACTUAL ROUTE SURVEY.

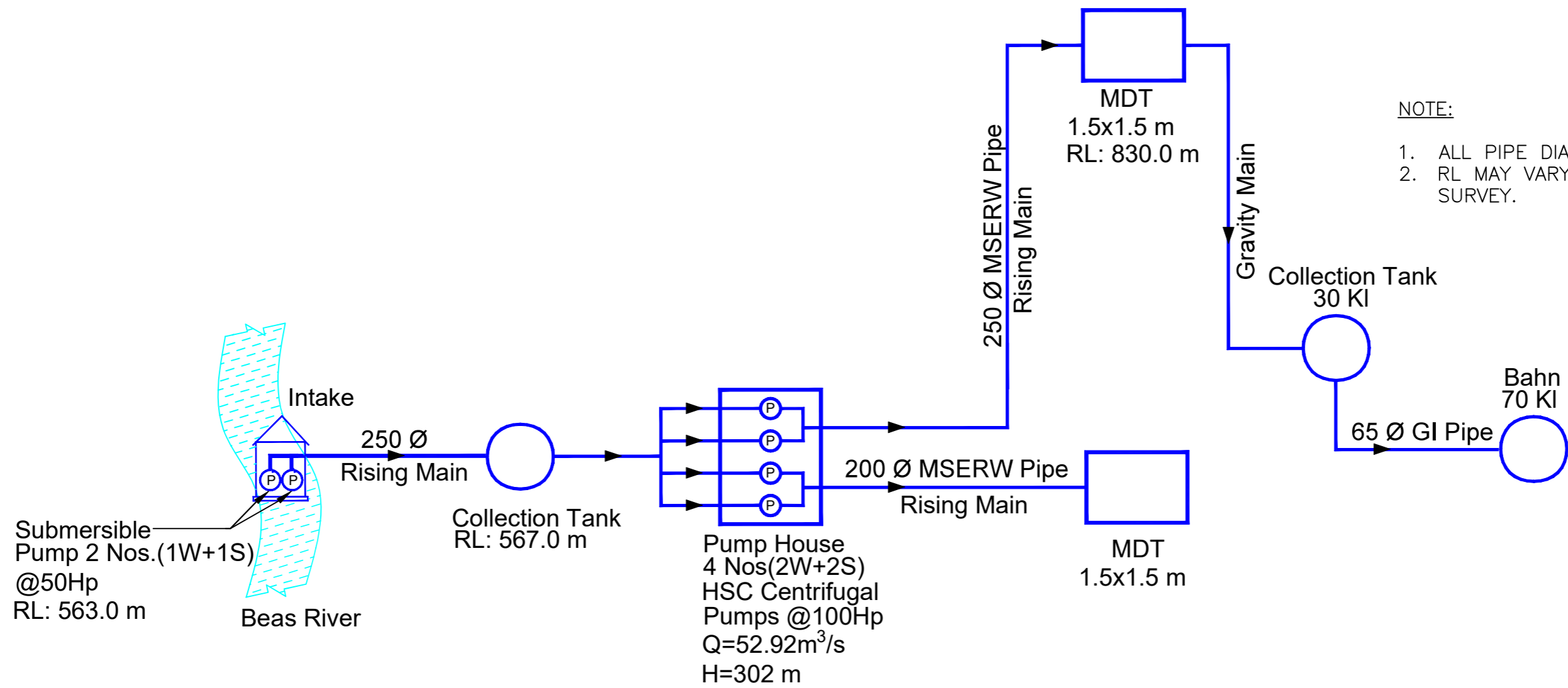

FLOW DIAGRAM – EXISTING LIS KOTHUA DHALLARA (FUNCTIONAL SCHEME)



SIGN.											
	INITIALS										
	REVISIONS										
PO	SIGN.										
	SM	MJ	DVB					MK	DK	01-06-2022	
	REVISIONS										
ISSUE	DRN	DSN	CHD	CV	EL	IC	ME		PE/PM	APPD	DATE
	CLEARED										

'P' (PRELIMINARY) ISSUES ARE NOT TO BE USED FOR CONSTRUCTION / FABRICATION BUT ARE ISSUED FOR LIMITED PURPOSES ONLY AS INDICATED IN THE SMALL BLOCK ABOVE THIS BLOCK.

CONSTRUCTION / FABRICATION WORK IS PERMITTED ON 'R' (RELEASED) ISSUES ONLY.

INFORMATION CONTAINED WITHIN 'HOLD' IS NOT RELEASED FOR CONSTRUCTION / FABRICATION. FIELD MUST GET DESIGN OFFICE TO CLEAR 'HOLDS' IN TIME BEFORE PROCEEDING WITH ANY CONSTRUCTION/ FABRICATION WORK RELATED TO 'HOLDS'.

SIGN. OF CLIENT:-			
JE	AE	EE	SE
PURPOSE: FOR TENDER ONLY			
DO NOT SCALE			
<small>Proprietary Notice and Version Control This document contains confidential information for use only by the Client. For the Project under consideration, which is provided for the sole purpose of permitting the recipient to evaluate the information submitted hereon, in consideration of receipt of this document, unless agreed to in contrary in the Contract, the recipient agrees to maintain such information in confidence and to not reproduce or otherwise disclose this information to any person outside the recipient's organization; except that there is no obligation to maintain the confidentiality of any information which was known to the recipient prior to receipt of such information from Tata Consulting Engineers Limited, or becomes publicly known through no fault of recipient, or Tata Consulting Engineers Limited, or is received without obligation of confidentiality from a third party using no obligation of confidentiality to Tata Consulting Engineers Limited. All information given under this version over rules all and any kind of others, conceptions, deliberations and contracts submitted verbally (and subsequently communicated in writing) or in writing or otherwise given under any and all previous versions.</small>			
FILE NAME 12503A-CV-32173-Rev-P0			

	DETAILED DESIGN CONSULTANCY, HP-SHIVA (PACKAGE CS09) IRRIGATION, HORTICULTURE, ORCHARDS AND VALUE CHAIN DEVELOPMENT	
	FLOW DIAGRAM FOR EXISTING LIS KOTHUA DHALLARA DHARAMPUR BLOCK MANDI DISTRICT	
	TATA CONSULTING ENGINEERS LIMITED MUMBAI	
SCALE : NTS	DWG NO. TCE.12503A-CV-3082-FD-32173	ISSUE PO
DC & DISC: DEL-CV		TCE FORM NO. 093 R1

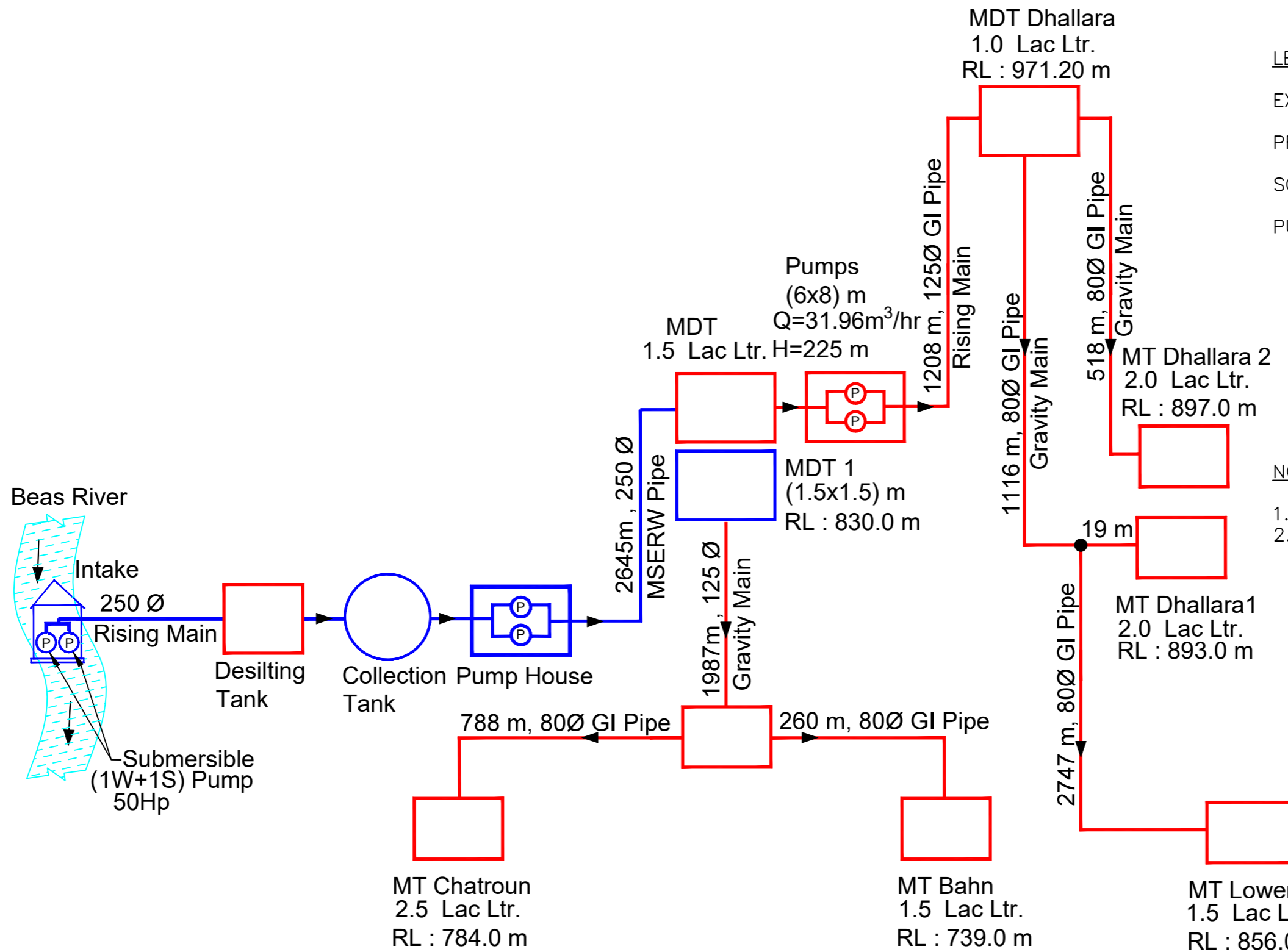

LEGEND:
 EXISTING COMPONENT
 PROPOSED COMPONENT
 SOURCE
 PUMP

NOTE:
 1. ALL PIPE DIAMETERS ARE IN MILLIMETER.
 2. RL MAY VARY AS PER ACTUAL ROUTE SURVEY.

FLOW DIAGRAM – PROPOSED LIS KOTHUA DHALLARA (FUNCTIONAL SCHEME – 34.94 Ha)

DETAILED DESIGN CONSULTANCY, HP-SHIVA (PACKAGE CS09) IRRIGATION, HORTICULTURE, ORCHARDS AND VALUE CHAIN DEVELOPMENT											
FLOW DIAGRAM FOR PROPOSED LIS KOTHUA DHALLARA DHARAMPUR BLOCK MANDI DISTRICT											
TATA CONSULTING ENGINEERS LIMITED MUMBAI											
SIGN. OF CLIENT: - JE AE EE SE				PURPOSE: FOR TENDER ONLY DO NOT SCALE							
PROPRIETARY NOTICE AND VERSION CONTROL: This document contains confidential information for use only by the Client. For the Project under consideration, which is provided for the sole purpose of permitting the recipient to evaluate the information submitted herewith, in consideration of receipt of this document, unless agreed to in writing in the Contract, the recipient agrees to maintain such information in confidence and to not reproduce or otherwise disclose this information to any person outside the recipient's organization, except that there is no obligation to maintain the confidentiality of any information which was known to the recipient prior to receipt of such information from Tata Consulting Engineers Limited, or becomes publicly known through no fault of recipient, or Tata Consulting Engineers Limited, or is received without obligation of confidentiality from a third party owing no obligation of confidentiality to Tata Consulting Engineers Limited. All information given under this version over rides all and any kind of offers, assumptions, deliberations and contracts submitted verbally (and subsequently communicated in writing) or in writing or otherwise given under any and all previous versions/s.				SCALE : NTS DWG NO. TCE.12503A-CV-3082-FD-32174 ISSUE P1 FILE NAME 12503A-CV-32174-Rev-P1 DC & DISC: DEL-CV							
P1 SIGN. INITIALS SM MJ DVB REVISIONS AS PER CLIENT COMMENTS		P0 SIGN. INITIALS SM MJ DVB REVISIONS		DRN DSN CHD		CV EL IC ME CLEARED		PE/PM APPD		DATE (dd-mm-yyyy)	
'P' (PRELIMINARY) ISSUES ARE NOT TO BE USED FOR CONSTRUCTION / FABRICATION BUT ARE ISSUED FOR LIMITED PURPOSES ONLY AS INDICATED IN THE SMALL BLOCK ABOVE THIS BLOCK. CONSTRUCTION / FABRICATION WORK IS PERMITTED ON 'R' (RELEASED) ISSUES ONLY. INFORMATION CONTAINED WITHIN 'HOLD' IS NOT RELEASED FOR CONSTRUCTION / FABRICATION. FIELD MUST GET DESIGN OFFICE TO CLEAR 'HOLDS' IN TIME BEFORE PROCEEDING WITH ANY CONSTRUCTION/ FABRICATION WORK RELATED TO 'HOLDS'.											

LEGEND:

EXISTING COMPONENT



SOURCE



PUMP



NOTE:

1. ALL PIPE DIAMETERS ARE IN MILLIMETER.
2. RL MAY VARY AS PER ACTUAL ROUTE SURVEY.

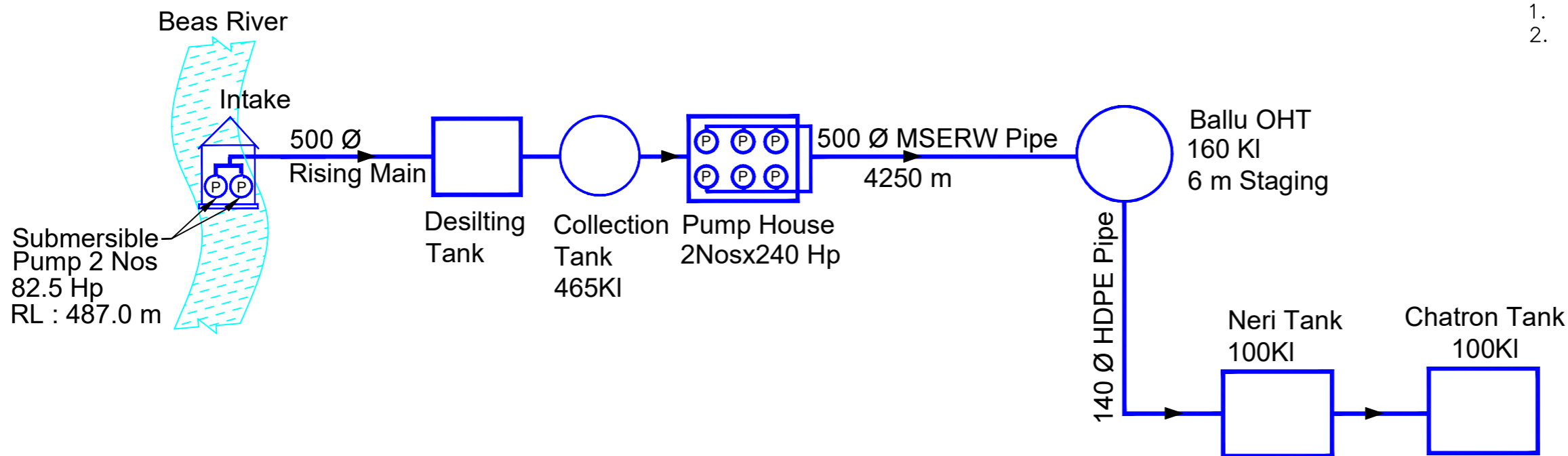

FLOW DIAGRAM – EXISTING LIS SANDHOLE (FUNCTIONAL SCHEME)

P1	SIGN.																					
	INITIALS	SM	MJ	DVB											MK	DK					20-07-2022	
	REVISIONS	AS PER CLIENT COMMENTS																				
P0	SIGN.																					
	INITIALS	SM	MJ	DVB																		01-06-2022
	REVISIONS																					
ISSUE		DRN	DSN	CHD	CV	EL	IC	ME			PE/PM	APPD	DATE									
													(dd-mm-yyyy)	CLEARED								

'P' (PRELIMINARY) ISSUES ARE NOT TO BE USED FOR CONSTRUCTION / FABRICATION BUT ARE ISSUED FOR LIMITED PURPOSES ONLY AS INDICATED IN THE SMALL BLOCK ABOVE THIS BLOCK.

CONSTRUCTION / FABRICATION WORK IS PERMITTED ON 'R' (RELEASED) ISSUES ONLY.

INFORMATION CONTAINED WITHIN 'HOLD' IS NOT RELEASED FOR CONSTRUCTION / FABRICATION. FIELD MUST GET DESIGN OFFICE TO CLEAR 'HOLDS' IN TIME BEFORE PROCEEDING WITH ANY CONSTRUCTION/ FABRICATION WORK RELATED TO 'HOLDS'.

SIGN. OF CLIENT:—

JE	AE	EE	SE

PURPOSE: FOR TENDER ONLY

DO NOT SCALE

Proprietary Notice and Version Control This document contains confidential information for use only by the Client. For the Project under consideration, which is provided for the sole purpose of permitting the recipient to evaluate the information submitted herewith, in consideration of receipt of this document, unless agreed to in contrary in the Contract, the recipient agrees to maintain such information in confidence and to not reproduce or otherwise disclose this information to any person outside the recipient's organization, except that there is no obligation to maintain the confidentiality of any information which was known to the recipient prior to receipt of such information from Tata Consulting Engineers Limited, or becomes publicly known through no fault of recipient, or Tata Consulting Engineers Limited, or is received without obligation of confidentiality from a third party using no obligation of confidentiality to Tata Consulting Engineers Limited. All information given under this version over rides all and any kind of offers, assumptions, deliveries and contracts submitted verbally (and subsequently communicated in writing) or in writing or otherwise given under any and all previous versions/s.

FILE NAME 12503A-CV-32175-Rev-P1

DETAILED DESIGN CONSULTANCY, HP-SHIVA (PACKAGE CS09)
IRRIGATION, HORTICULTURE, ORCHARDS AND VALUE CHAIN DEVELOPMENT

FLOW DIAGRAM FOR EXISTING LIS SANDHOLE
DHARAMPUR BLOCK MANDI DISTRICT

TATA CONSULTING ENGINEERS LIMITED
MUMBAI

SCALE : NTS DWG NO. TCE.12503A-CV-3082-FD-32175 ISSUE P1

DC & DISC: DEL-CV

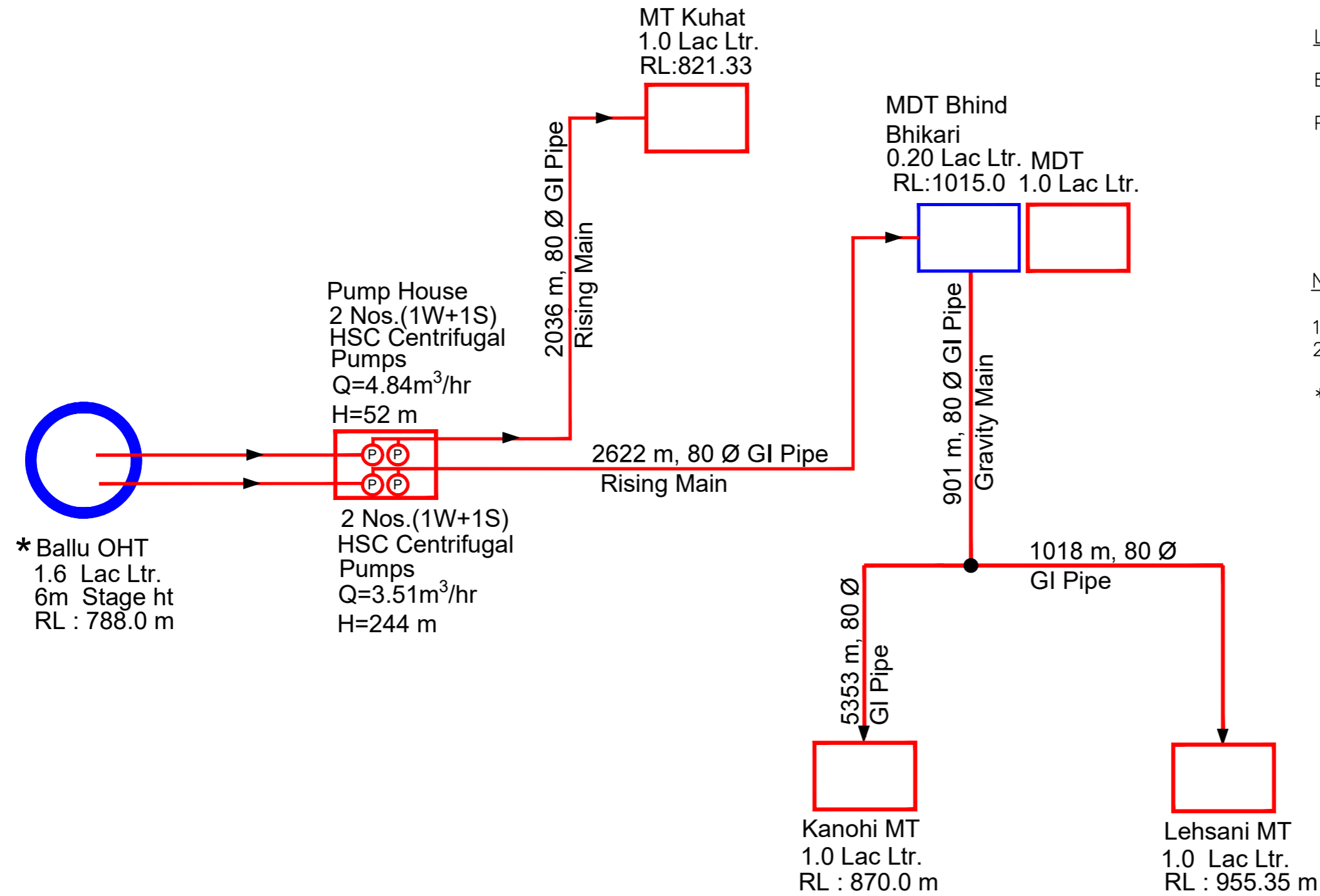

LEGEND:

- EXISTING COMPONENT →
- PROPOSED COMPONENT →

NOTE:

1. ALL PIPE DIAMETERS ARE IN MILLIMETER.
2. RL MAY VARY AS PER ACTUAL ROUTE SURVEY.

* REFER DRAWING NO. TCE.12503A-CV-3082-FD-32175 FOR EXISTING LIS DETAILS.

FLOW DIAGRAM – PROPOSED LIS SANDHOLE (FUNCTIONAL SCHEME – 6.37 Ha)



DETAILED DESIGN CONSULTANCY, HP-SHIVA (PACKAGE CS09)
IRRIGATION, HORTICULTURE, ORCHARDS AND VALUE CHAIN DEVELOPMENT

FLOW DIAGRAM FOR PROPOSED LIS SANDHOLE
DHARAMPUR BLOCK MANDI DISTRICT

SIGN. OF CLIENT:-

JE	AE	EE	SE
----	----	----	----

PURPOSE: FOR TENDER ONLY

DO NOT SCALE

Proprietary Notice and Version Control: This document contains confidential information for use only by the Client for the Project under consideration, which is provided for the sole purpose of permitting the recipient to evaluate the information submitted hereunder in consideration of receipt of this document. The recipient agrees to maintain such information in confidence and to not reproduce or otherwise disclose this information to any person outside the recipient's organization except that there is no obligation to maintain the confidentiality of any information which was known to the recipient prior to receipt of such information from Tata Consulting Engineers Limited, or becomes publicly known through no fault of recipient, or Tata Consulting Engineers Limited, or is received without obligation of confidentiality from a third party owing no obligation of confidentiality to Tata Consulting Engineers Limited. All information given under this version over rides all and any kind of offers, assumptions, observations and contracts submitted verbally (and subsequently communicated in writing) or in writing or otherwise given under any and all previous versions/s.

FILE NAME: 12503A-CV-32176-Rev-P1



TATA CONSULTING ENGINEERS LIMITED
MUMBAI

SCALE : NTS	DWG NO. TCE.12503A-CV-3082-FD-32176	ISSUE P1	
DC & DISC: DEL-CV			

P1	SIGN.	SM	MJ	DVB											20-07-2022	'P' (PRELIMINARY) ISSUES ARE NOT TO BE USED FOR CONSTRUCTION / FABRICATION BUT ARE ISSUED FOR LIMITED PURPOSES ONLY AS INDICATED IN THE SMALL BLOCK ABOVE THIS BLOCK.
	INITIALS															
	REVISIONS	AS PER CLIENT COMMENTS														
P0	SIGN.	SM	MJ	DVB												CONSTRUCTION / FABRICATION WORK IS PERMITTED ON 'R' (RELEASED) ISSUES ONLY.
	INITIALS															
	REVISIONS															
ISSUE	DRN	DSN	CHD	CV	EL	IC	ME	PE/PM	APPD	DATE (dd-mm-yyy)	CLEARED					INFORMATION CONTAINED WITHIN 'HOLD' IS NOT RELEASED FOR CONSTRUCTION / FABRICATION. FIELD MUST GET DESIGN OFFICE TO CLEAR 'HOLDS' IN TIME BEFORE PROCEEDING WITH ANY CONSTRUCTION/ FABRICATION WORK RELATED TO 'HOLDS'.

LEGEND:

EXISTING COMPONENT 



TUBEWELL 

NOTE:

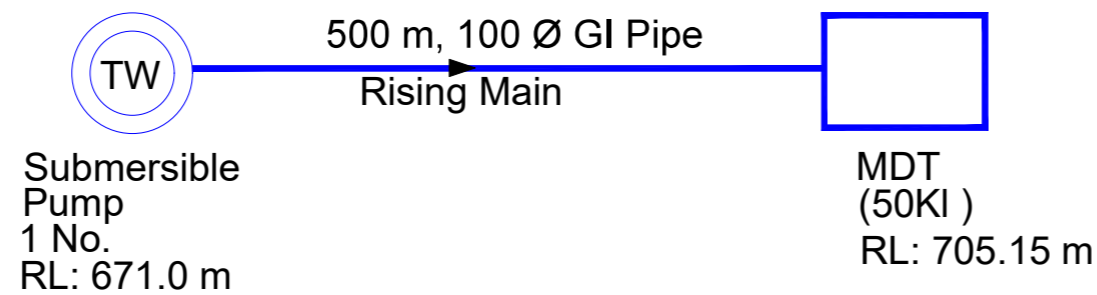
1. ALL PIPE DIAMETERS ARE IN MILLIMETER.
2. RL MAY VARY AS PER ACTUAL ROUTE SURVEY.



FLOW DIAGRAM – EXISTING LIS CHURU BALH (FUNCTIONAL SCHEME)

												 DETAILED DESIGN CONSULTANCY, HP-SHIVA (PACKAGE CS09) IRRIGATION, HORTICULTURE, ORCHARDS AND VALUE CHAIN DEVELOPMENT											
												SIGN. OF CLIENT:- <table border="1" style="width:100%; height: 20px; border-collapse: collapse;"> <tr> <td style="width: 25%;"></td> <td style="width: 25%;"></td> <td style="width: 25%;"></td> <td style="width: 25%;"></td> </tr> <tr> <td style="text-align: center;">JE</td> <td style="text-align: center;">AE</td> <td style="text-align: center;">EE</td> <td style="text-align: center;">SE</td> </tr> </table>								JE	AE	EE	SE
JE	AE	EE	SE																				
												FLOW DIAGRAM FOR EXISTING LIS CHURU BALH DHARAMPUR BLOCK MANDI DISTRICT											
												 TATA CONSULTING ENGINEERS LIMITED MUMBAI											
SIGN.		INITIALS		REVISIONS		SIGN.		INITIALS		REVISIONS		PURPOSE: FOR TENDER ONLY		DO NOT SCALE		SCALE : NTS		DWG NO.		ISSUE			
												CONSTRUCTION / FABRICATION WORK IS PERMITTED ON 'R' (RELEASED) ISSUES ONLY.		<small>Proprietary Notice and Version Control This document contains confidential information for use only by the Client. In the Project under consideration, which is provided for the sole purpose of permitting the recipient to evaluate the information submitted hereon, in consideration of receipt of this document, unless agreed to in contrary in the Contract, the recipient agrees to maintain such information in confidence and to not reproduce or otherwise disclose this information to any person outside the recipient's organization, except that there is no obligation to maintain the confidentiality of any information which was known to the recipient prior to receipt of such information from Tata Consulting Engineers Limited, or becomes publicly known through no fault of recipient, or Tata Consulting Engineers Limited, or is received without obligation of confidentiality from a third party using no obligation of confidentiality to Tata Consulting Engineers Limited. All information given under this version over time all and any kind of offers, conceptions, deliberations and contracts submitted verbally (and subsequently communicated in writing) or in writing or otherwise given under any and all previous versions/s.</small>		TCE.12503A-CV-3082-FD-32177		PO					
PO		SM		MK		DVB				MK		DK		01-06-2022		INFORMATION CONTAINED WITHIN 'HOLD' IS NOT RELEASED FOR CONSTRUCTION / FABRICATION. FIELD MUST GET DESIGN OFFICE TO CLEAR 'HOLDS' IN TIME BEFORE PROCEEDING WITH ANY CONSTRUCTION/ FABRICATION WORK RELATED TO 'HOLDS'.		FILE NAME		12503A-CV-32177-Rev-P0			
ISSUE		DRN		DSN		CHD		CV		EL		IC		ME		PE/PM		APPD		DATE			

LEGEND:

- EXISTING COMPONENT
- PROPOSED COMPONENT
- SOURCE
- TUBEWELL

NOTE:

1. ALL PIPE DIAMETERS ARE IN MILLIMETER.
2. RL MAY VARY AS PER ACTUAL ROUTE SURVEY.

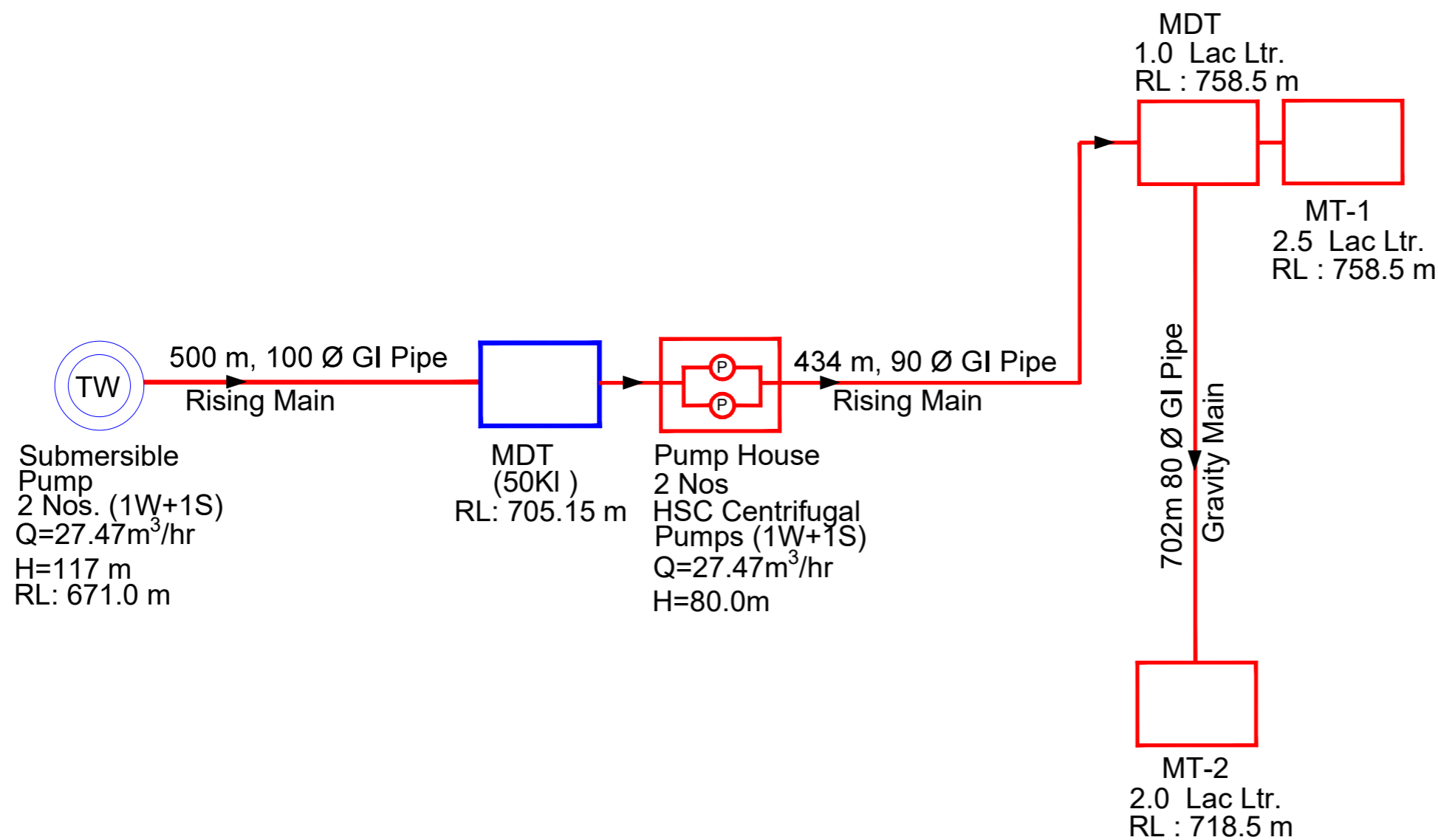

FLOW DIAGRAM – PROPOSED LIS CHURU BALH (FUNCTIONAL SCHEME – 20.88 Hd)

P1	SIGN.												20-07-2022
	INITIALS	SM	MJ	DVB						MK	DK		
	REVISIONS	AS PER CLIENT COMMENTS											
P0	SIGN.												01-06-2022
	INITIALS	SM	MK	DVB						MK	DK		
	REVISIONS												
ISSUE		DRN	DSN	CHD	CV	EL	IC	ME		PE/PM	APPD	DATE	
												(dd-mm-yyyy)	
CLEARED													

'P' (PRELIMINARY) ISSUES ARE NOT TO BE USED FOR CONSTRUCTION / FABRICATION BUT ARE ISSUED FOR LIMITED PURPOSES ONLY AS INDICATED IN THE SMALL BLOCK ABOVE THIS BLOCK.

CONSTRUCTION / FABRICATION WORK IS PERMITTED ON 'R' (RELEASED) ISSUES ONLY.

INFORMATION CONTAINED WITHIN 'HOLD' IS NOT RELEASED FOR CONSTRUCTION / FABRICATION. FIELD MUST GET DESIGN OFFICE TO CLEAR 'HOLDS' IN TIME BEFORE PROCEEDING WITH ANY CONSTRUCTION/ FABRICATION WORK RELATED TO 'HOLDS'.

SIGN. OF CLIENT:-

JE	AE	EE	SE

PURPOSE: FOR TENDER ONLY

DO NOT SCALE

Proprietary Notice and Version Control This document contains confidential information for use only by the Client for the Project under consideration, which is provided for the sole purpose of permitting the recipient to evaluate the information submitted hereunder. In consideration of receipt of this document, the recipient agrees to maintain such information in confidence and to not reproduce or otherwise disclose this information to any person outside the recipient's organization, except that there is no obligation to maintain the confidentiality of any information which was known to the recipient prior to receipt of such information from Tata Consulting Engineers Limited, or becomes publicly known through no fault of recipient, or Tata Consulting Engineers Limited, or is received without obligation of confidentiality from a third party using no obligation of confidentiality to Tata Consulting Engineers Limited. All information given under this version over rides all and any kind of offers, assumptions, deliberations and contracts submitted verbally (and subsequently communicated in writing) or in writing or otherwise given under any and all previous version/s.

FILE NAME 12503A-CV-32178-Rev-P1

DETAILED DESIGN CONSULTANCY, HP-SHIVA (PACKAGE CS09)
IRRIGATION, HORTICULTURE, ORCHARDS AND VALUE CHAIN DEVELOPMENT

FLOW DIAGRAM FOR PROPOSED LIS CHURU BALH
DHARAMPUR BLOCK MANDI DISTRICT

TATA CONSULTING ENGINEERS LIMITED
MUMBAI

SCALE : NTS DWG NO. TCE.12503A-CV-3082-FD-32178 ISSUE P1

DC & DISC: DEL-CV

LEGEND:

EXISTING COMPONENT



SOURCE



PUMP

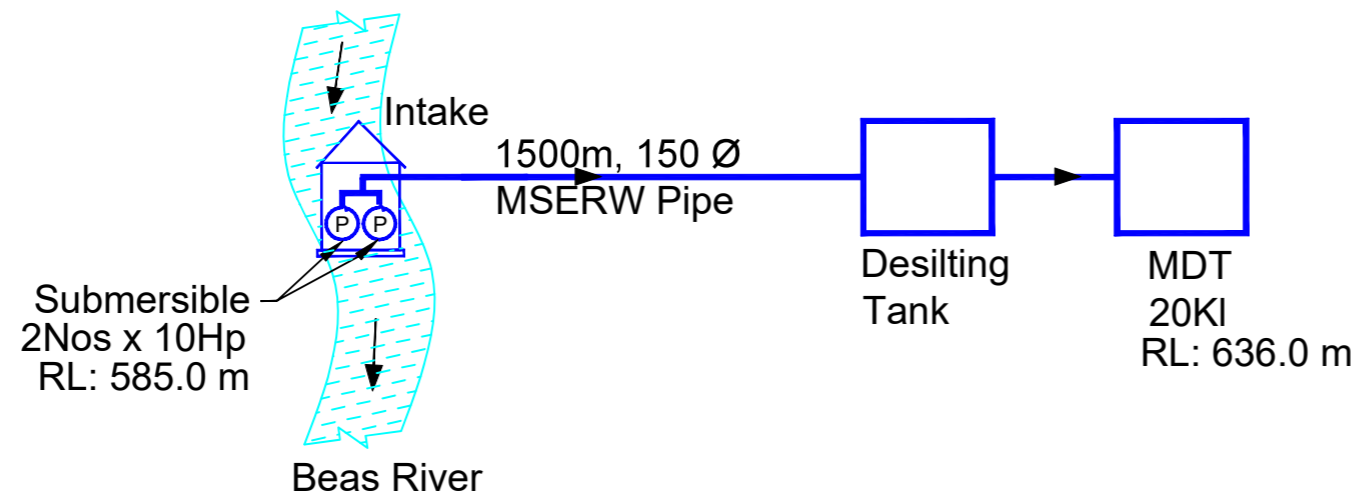

FLOW DIAGRAM – EXISTING LIS SEOH (FUNCTIONAL SCHEME)

DETAILED DESIGN CONSULTANCY, HP-SHIVA (PACKAGE CS09)
IRRIGATION, HORTICULTURE, ORCHARDS AND VALUE CHAIN DEVELOPMENT

FLOW DIAGRAM FOR EXISTING LIS SEOH
DHARAMPUR BLOCK MANDI DISTRICT

SIGN. OF CLIENT:-

JE	AE	EE	SE
----	----	----	----

PURPOSE: FOR TENDER ONLY

DO NOT SCALE



TATA CONSULTING ENGINEERS LIMITED
MUMBAI

Proprietary Notice and Version Control This document contains confidential information for use only by the Client. For the Project under consideration, which is provided for the sole purpose of permitting the recipient to evaluate the information submitted hereon, in consideration of receipt of this document, unless agreed to in contrary in the Contract, the recipient agrees to maintain such information in confidence and to not reproduce or otherwise disclose this information to any person outside the recipient's organization; except that there is no obligation to maintain the confidentiality of any information which was known to the recipient prior to receipt of such information from Tata Consulting Engineers Limited, or becomes publicly known through no fault of recipient, or Tata Consulting Engineers Limited, or is received without obligation of confidentiality from a third party owing no obligation of confidentiality to Tata Consulting Engineers Limited. All information given under this version over time and any kind of offers, conceptions, deliberations and contracts submitted verbally (and subsequently communicated in writing) or in writing or otherwise given under any and all previous versions/s.

FILE NAME 12503A-CV-32179-Rev-P0

SCALE : NTS
DC & DISC: DEL-CV

DWG NO. TCE.12503A-CV-3082-FD-32179

ISSUE PO

SIGN.																									
	INITIALS																								
	REVISIONS																								
PO	SIGN.																								
	INITIALS	SM	MJ	DVB							MK	DK	01-06-2022												
	REVISIONS																								
ISSUE		DRN	DSN	CHD	CV	EL	IC	ME		PE/PM	APPD	DATE													
														CLEARED											

'P' (PRELIMINARY) ISSUES ARE NOT TO BE USED FOR CONSTRUCTION / FABRICATION BUT ARE ISSUED FOR LIMITED PURPOSES ONLY AS INDICATED IN THE SMALL BLOCK ABOVE THIS BLOCK.

CONSTRUCTION / FABRICATION WORK IS PERMITTED ON 'R' (RELEASED) ISSUES ONLY.

INFORMATION CONTAINED WITHIN 'HOLD' IS NOT RELEASED FOR CONSTRUCTION / FABRICATION. FIELD MUST GET DESIGN OFFICE TO CLEAR 'HOLDS' IN TIME BEFORE PROCEEDING WITH ANY CONSTRUCTION/ FABRICATION WORK RELATED TO 'HOLDS'.

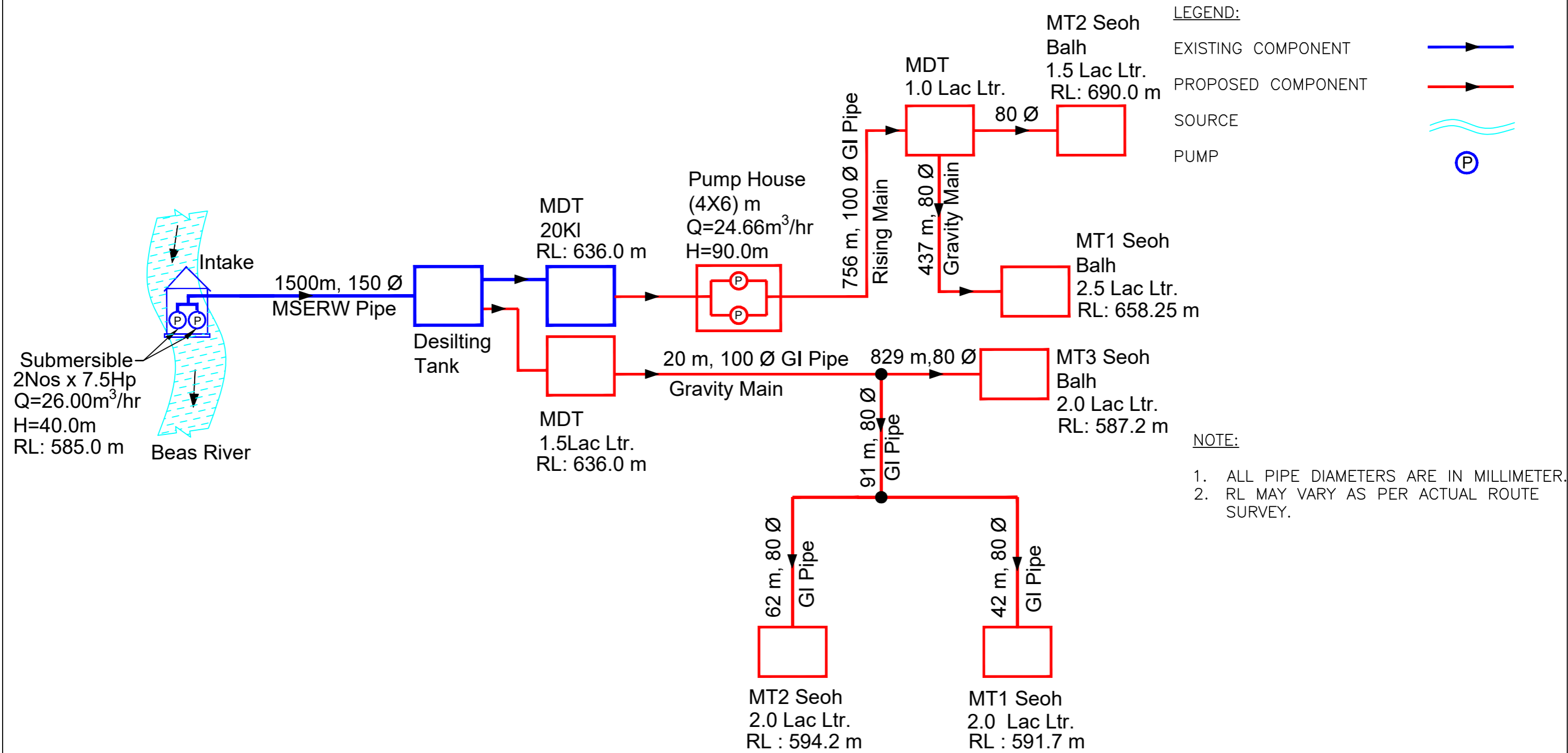

LEGEND:

- EXISTING COMPONENT
- PROPOSED COMPONENT
- SOURCE
- PUMP

NOTE:

1. ALL PIPE DIAMETERS ARE IN MILLIMETER.
2. RL MAY VARY AS PER ACTUAL ROUTE SURVEY.

FLOW DIAGRAM – PROPOSED LIS SEOH (FUNCTIONAL SCHEME – 46.23 Ha)

DETAILED DESIGN CONSULTANCY, HP-SHIVA (PACKAGE CS09) IRRIGATION, HORTICULTURE, ORCHARDS AND VALUE CHAIN DEVELOPMENT																	
SIGN. OF CLIENT: - <table style="width: 100%; border: none;"> <tr> <td style="border: none; width: 25%; height: 20px;"></td> <td style="border: none; width: 25%; height: 20px;"></td> <td style="border: none; width: 25%; height: 20px;"></td> <td style="border: none; width: 25%; height: 20px;"></td> </tr> <tr> <td style="border: none; text-align: center;">JE</td> <td style="border: none; text-align: center;">AE</td> <td style="border: none; text-align: center;">EE</td> <td style="border: none; text-align: center;">SE</td> </tr> </table>														JE	AE	EE	SE
JE	AE	EE	SE														
FLOW DIAGRAM FOR PROPOSED LIS SEOH DHARAMPUR BLOCK MANDI DISTRICT																	
TATA CONSULTING ENGINEERS LIMITED MUMBAI																	
P1 SIGN. INITIALS: SM MJ DVB MK DK REVISIONS: AS PER CLIENT COMMENTS DATE: 20-07-2022					P0 SIGN. INITIALS: SM MJ DVB MK DK REVISIONS: DATE: 01-06-2022												
'P' (PRELIMINARY) ISSUES ARE NOT TO BE USED FOR CONSTRUCTION / FABRICATION BUT ARE ISSUED FOR LIMITED PURPOSES ONLY AS INDICATED IN THE SMALL BLOCK ABOVE THIS BLOCK. CONSTRUCTION / FABRICATION WORK IS PERMITTED ON 'R' (RELEASED) ISSUES ONLY. INFORMATION CONTAINED WITHIN 'HOLD' IS NOT RELEASED FOR CONSTRUCTION / FABRICATION. FIELD MUST GET DESIGN OFFICE TO CLEAR 'HOLDS' IN TIME BEFORE PROCEEDING WITH ANY CONSTRUCTION/ FABRICATION WORK RELATED TO 'HOLDS'.																	
ISSUE		DRN	DSN	CHD	CV	EL	IC	ME	PE/PM	APPD	DATE	FILE NAME	SCALE	DWG NO.	ISSUE		
											(dd-mm-yyyy)	12503A-CV-32180-Rev-P1	: NTS	TCE.12503A-CV-3082-FD-32180	P1		
TCE FORM NO. 093 R1																	

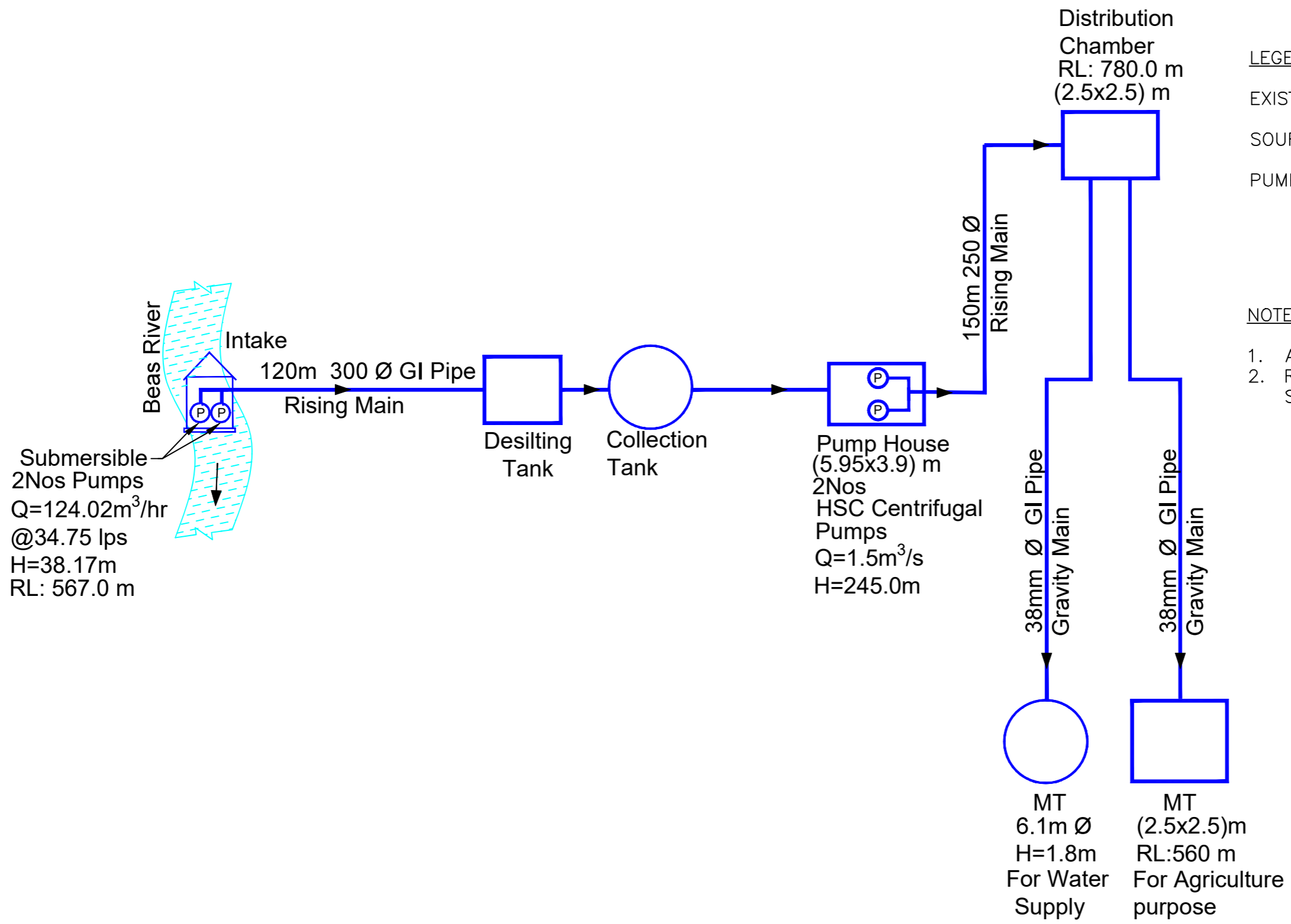

LEGEND:
 EXISTING COMPONENT
 SOURCE
 PUMP

NOTE:
 1. ALL PIPE DIAMETERS ARE IN MILLIMETER.
 2. RL MAY VARY AS PER ACTUAL ROUTE SURVEY.

FLOW DIAGRAM – EXISTING LIS BAIRI (FUNCTIONAL SCHEME)

DETAILED DESIGN CONSULTANCY, HP-SHIVA (PACKAGE CS09)
 IRRIGATION, HORTICULTURE, ORCHARDS AND VALUE CHAIN DEVELOPMENT

FLOW DIAGRAM FOR EXISTING LIS BAIRI
 DHARAMPUR BLOCK MANDI DISTRICT

SIGN. OF CLIENT: -
 JE AE EE SE
 PURPOSE: FOR TENDER ONLY
 DO NOT SCALE

TATA CONSULTING ENGINEERS LIMITED
 MUMBAI

PROPRIETARY NOTICE AND VERSION CONTROL: This document contains confidential information for use only by the Client. For the Project under consideration, which is provided for the sole purpose of permitting the recipient to evaluate the information submitted hereon, in consideration of receipt of this document, unless agreed to in contrary in the Contract, the recipient agrees to maintain such information in confidence and to not reproduce or otherwise disclose this information to any person outside the recipient's organization, except that there is no obligation to maintain the confidentiality of any information which was known to the recipient prior to receipt of such information from Tata Consulting Engineers Limited, or becomes publicly known through no fault of recipient, or Tata Consulting Engineers Limited, or is received without obligation of confidentiality from a third party using no obligation of confidentiality to Tata Consulting Engineers Limited. All information given under this version over time all and any kind of offers, consultations, deliberations and contracts submitted verbally (and subsequently communicated in writing) or in writing or otherwise given under any and all previous version/s.

INFORMATION CONTAINED WITHIN 'HOLD' IS NOT RELEASED FOR CONSTRUCTION / FABRICATION. FIELD MUST GET DESIGN OFFICE TO CLEAR 'HOLDS' IN TIME BEFORE PROCEEDING WITH ANY CONSTRUCTION/ FABRICATION WORK RELATED TO 'HOLDS'.

FILE NAME 12503A-CV-32181-Rev-P0

SIGN.	INITIALS										
	REVISIONS										
	INFORMATION CONTAINED WITHIN 'HOLD' IS NOT RELEASED FOR CONSTRUCTION / FABRICATION. FIELD MUST GET DESIGN OFFICE TO CLEAR 'HOLDS' IN TIME BEFORE PROCEEDING WITH ANY CONSTRUCTION/ FABRICATION WORK RELATED TO 'HOLDS'.										
PO	INITIALS	SM	MJ	DVB					MK	DK	01-06-2022
	REVISIONS										
	CONSTRUCTION / FABRICATION WORK IS PERMITTED ON 'R' (RELEASED) ISSUES ONLY.										
ISSUE	DRN	DSN	CHD	CV	EL	IC	ME		PE/PM	APPD	DATE
											(dd-mm-yyyy)
CLEARED											

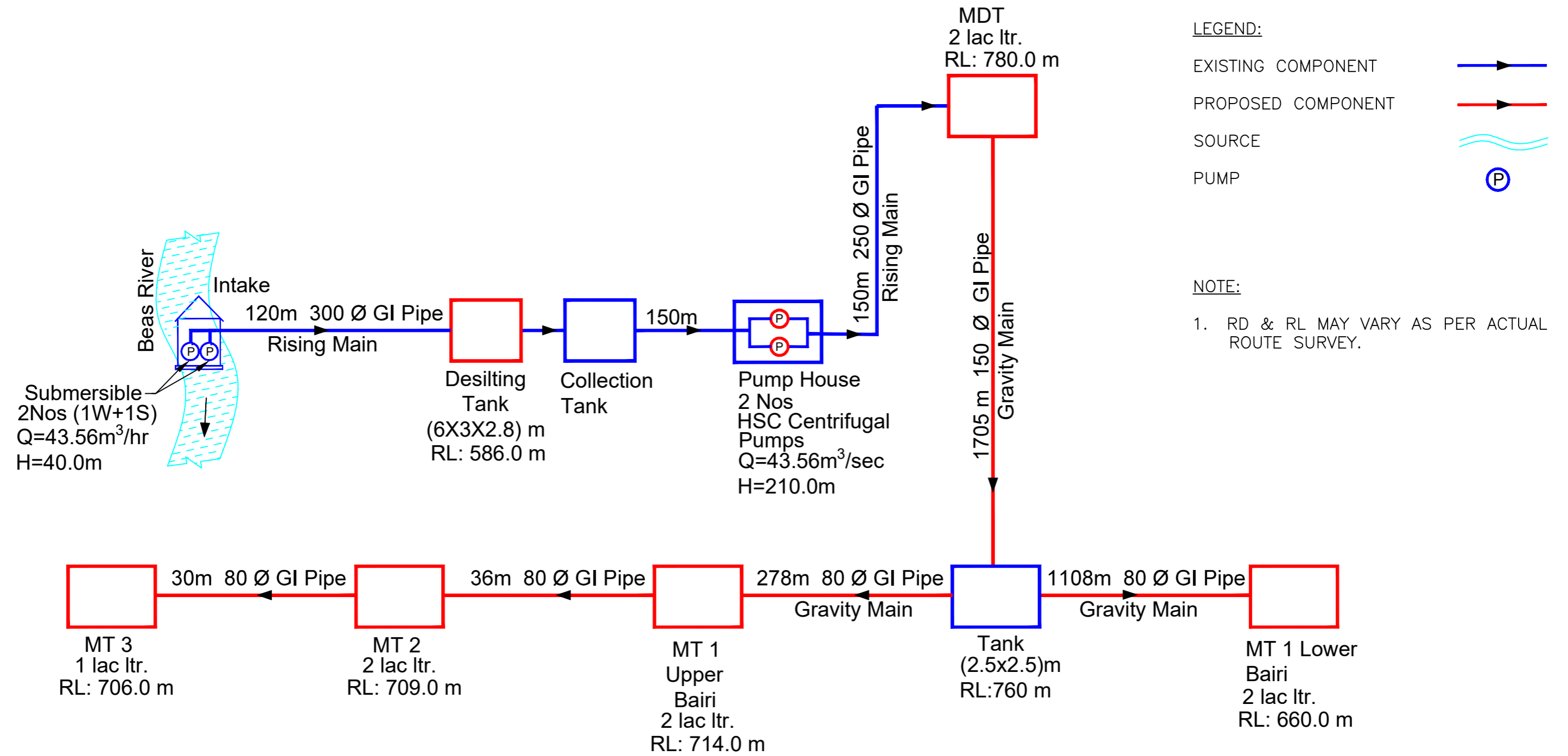

LEGEND:
 EXISTING COMPONENT → (blue line)
 PROPOSED COMPONENT → (red line)
 SOURCE (Beas River)
 PUMP (P)

NOTE:
 1. RD & RL MAY VARY AS PER ACTUAL ROUTE SURVEY.

FLOW DIAGRAM – PROPOSED LIS BAIRI (NON FUNCTIONAL SCHEME – 33.11 Ha)

P1	SIGN.											20-07-2022
	INITIALS	SM	MJ	DVB						MK	DK	
REVISIONS AS PER CLIENT COMMENTS												
P0	SIGN.											01-06-2022
	INITIALS	SM	MJ	DVB						MK	DK	
REVISIONS												
ISSUE	DRN	DSN	CHD	CV	EL	IC	ME		PE/PM	APPD	DATE	(dd-mm-yyyy)
	CLEARED											

'P' (PRELIMINARY) ISSUES ARE NOT TO BE USED FOR CONSTRUCTION / FABRICATION BUT ARE ISSUED FOR LIMITED PURPOSES ONLY AS INDICATED IN THE SMALL BLOCK ABOVE THIS BLOCK.
 CONSTRUCTION / FABRICATION WORK IS PERMITTED ON 'R' (RELEASED) ISSUES ONLY.
 INFORMATION CONTAINED WITHIN 'HOLD' IS NOT RELEASED FOR CONSTRUCTION / FABRICATION. FIELD MUST GET DESIGN OFFICE TO CLEAR 'HOLDS' IN TIME BEFORE PROCEEDING WITH ANY CONSTRUCTION/ FABRICATION WORK RELATED TO 'HOLDS'.

SIGN. OF CLIENT:—

JE	AE	EE	SE
----	----	----	----

PURPOSE: FOR TENDER ONLY
 DO NOT SCALE

Proprietary Notice and Version Control: This document contains confidential information for use only by the Client. For the Project under consideration, which is provided for the sole purpose of permitting the recipient to evaluate the information submitted herewith, in consideration of receipt of this document, unless agreed to in contrary in the Contract, the recipient agrees to maintain such information in confidence and to not reproduce or otherwise disclose this information to any person outside the recipient's organization; except that there is no obligation to maintain the confidentiality of any information which was known to the recipient prior to receipt of such information from Tata Consulting Engineers Limited, or becomes publicly known through no fault of recipient, or Tata Consulting Engineers Limited, or is received without obligation of confidentiality from a third party using no obligation of confidentiality to Tata Consulting Engineers Limited. All information given under this version over rides all and any kind of offers, assumptions, deliverables and contracts submitted verbally (and subsequently communicated in writing) or in writing or otherwise given under any and all previous versions/s.

FILE NAME 12503A-CV-32182-Rev-P1

DETAILED DESIGN CONSULTANCY, HP-SHIVA (PACKAGE CS09)
 IRRIGATION, HORTICULTURE, ORCHARDS AND VALUE CHAIN DEVELOPMENT

FLOW DIAGRAM FOR PROPOSED LIS BAIRI
 DHARAMPUR BLOCK MANDI DISTRICT

TATA CONSULTING ENGINEERS LIMITED
 MUMBAI

SCALE : NTS DWG NO. TCE.12503A-CV-3082-FD-32182 ISSUE P1
 DC & DISC: DEL-CV

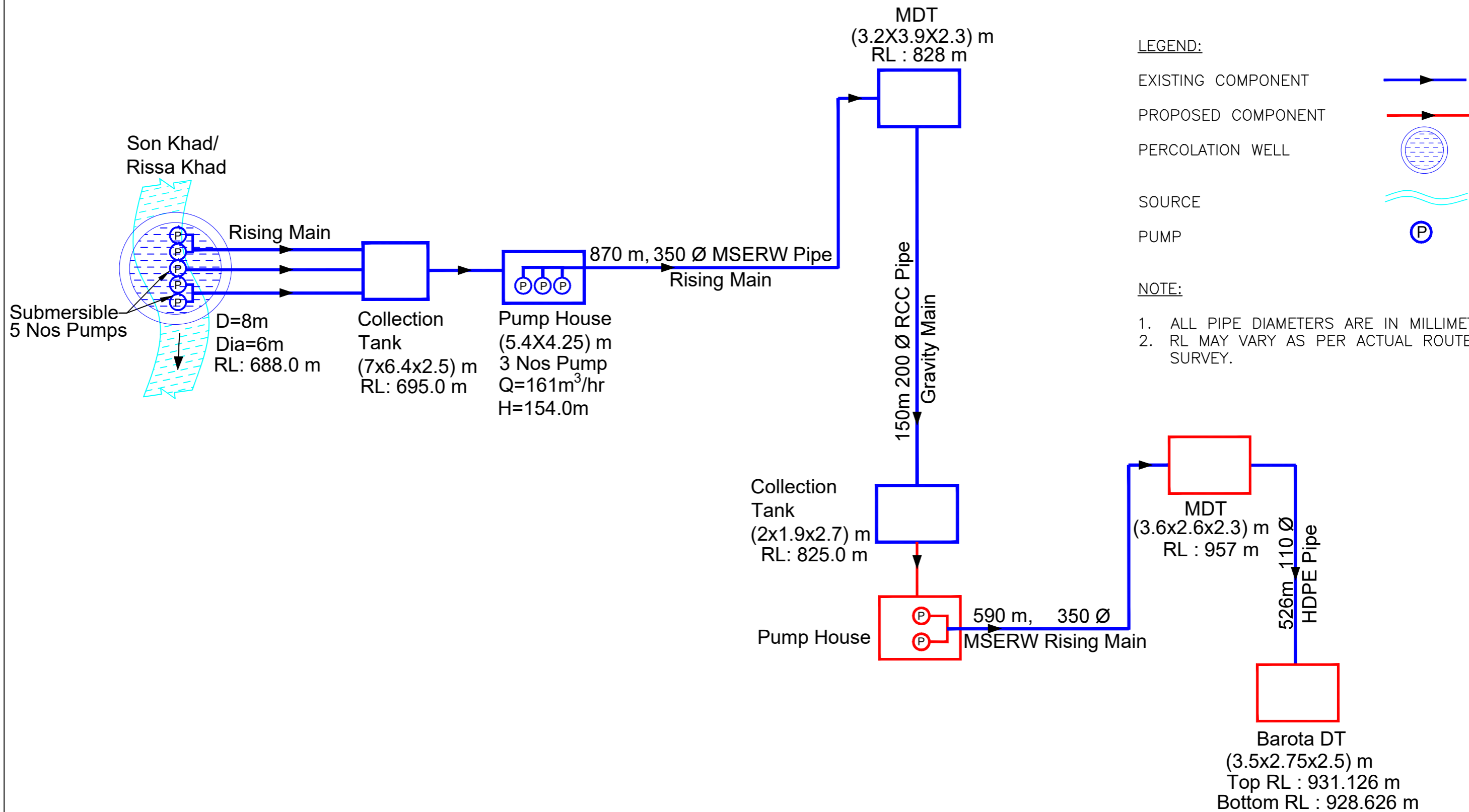

- LEGEND:**
- EXISTING COMPONENT
 - PROPOSED COMPONENT
 - PERCOLATION WELL
 - SOURCE
 - PUMP

- NOTE:**
- ALL PIPE DIAMETERS ARE IN MILLIMETER.
 - RL MAY VARY AS PER ACTUAL ROUTE SURVEY.

FLOW DIAGRAM – EXISTING LIS BRANG (FUNCTIONAL SCHEME)

SIGN.										
	INITIALS									
	REVISIONS									
PO	SIGN.									
	SM	MJ	DVB					MK	DK	01-06-2022
	REVISIONS									
ISSUE	DRN	DSN	CHD	CV	EL	IC	ME	PE/PM	APPD	DATE
	CLEARED									

'P' (PRELIMINARY) ISSUES ARE NOT TO BE USED FOR CONSTRUCTION / FABRICATION BUT ARE ISSUED FOR LIMITED PURPOSES ONLY AS INDICATED IN THE SMALL BLOCK ABOVE THIS BLOCK.

CONSTRUCTION / FABRICATION WORK IS PERMITTED ON 'R' (RELEASED) ISSUES ONLY.

INFORMATION CONTAINED WITHIN 'HOLD' IS NOT RELEASED FOR CONSTRUCTION / FABRICATION. FIELD MUST GET DESIGN OFFICE TO CLEAR 'HOLDS' IN TIME BEFORE PROCEEDING WITH ANY CONSTRUCTION/FABRICATION WORK RELATED TO 'HOLDS'.

SIGN. OF CLIENT: -

JE	AE	EE	SE
----	----	----	----

PURPOSE: FOR TENDER ONLY

DO NOT SCALE

Proprietary Notice and Version Control This document contains confidential information for use only by the Client; for the Project under consideration, which is provided for the sole purpose of permitting the recipient to evaluate the information submitted hereunder, in consideration of receipt of this document; unless agreed to in writing in the Contract, the recipient agrees to maintain such information in confidence and to not reproduce or otherwise disclose this information to any person outside the recipient's organization; except that there is no obligation to maintain the confidentiality of any information which was known to the recipient prior to receipt of such information from Tata Consulting Engineers Limited, or becomes publicly known through no fault of recipient, or Tata Consulting Engineers Limited, or is received without obligation of confidentiality from a third party owing no obligation of confidentiality to Tata Consulting Engineers Limited. All information given under this version over time and any kind of others, correspondence, deliberations and contracts submitted verbally (and subsequently communicated in writing) or in writing or otherwise given under any and all previous versions/versions (and subsequently communicated in writing) or in writing or otherwise given under any and all previous versions/versions.

FILE NAME 12503A-CV-32183-Rev-P0

DETAILED DESIGN CONSULTANCY, HP-SHIVA (PACKAGE CS09)
IRRIGATION, HORTICULTURE, ORCHARDS AND VALUE CHAIN DEVELOPMENT

FLOW DIAGRAM FOR EXISTING LIS BRANG
DHARAMPUR BLOCK MANDI DISTRICT

TATA CONSULTING ENGINEERS LIMITED
MUMBAI

SCALE : NTS	DWG NO.	2183XXXX	ISSUE	PO
DC & DISC: DEL-CV				

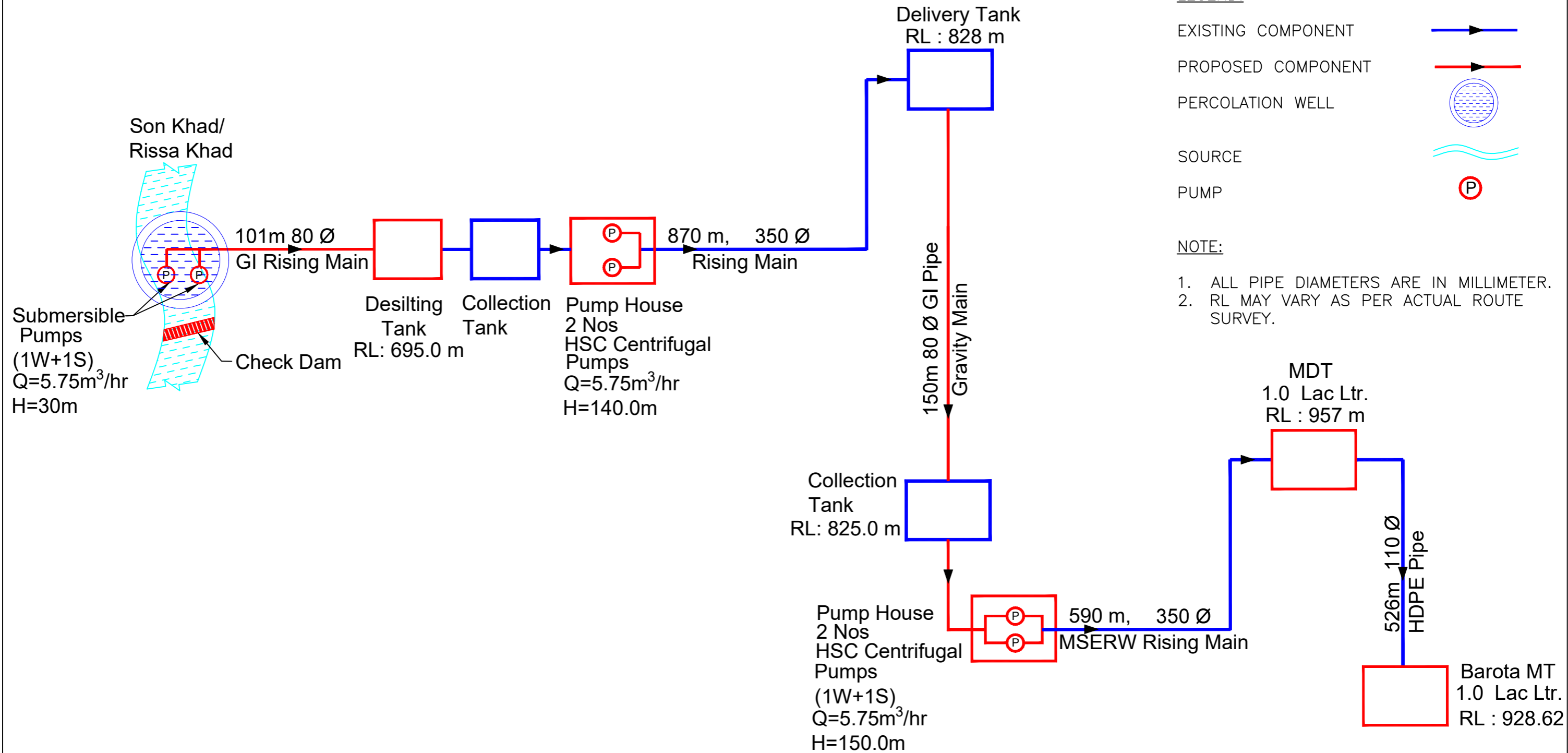

- LEGEND:**
- EXISTING COMPONENT
 - PROPOSED COMPONENT
 - PERCOLATION WELL
 - SOURCE
 - PUMP

- NOTE:**
1. ALL PIPE DIAMETERS ARE IN MILLIMETER.
 2. RL MAY VARY AS PER ACTUAL ROUTE SURVEY.

FLOW DIAGRAM – PROPOSED LIS BRANG (NEW SCHEME – 4.37 Ha)

DETAILED DESIGN CONSULTANCY, HP-SHIVA (PACKAGE CS09) IRRIGATION, HORTICULTURE, ORCHARDS AND VALUE CHAIN DEVELOPMENT													
SIGN. OF CLIENT:– <table style="width: 100%; height: 40px; border: none;"> <tr> <td style="width: 25%; border: none;">JE</td> <td style="width: 25%; border: none;">AE</td> <td style="width: 25%; border: none;">EE</td> <td style="width: 25%; border: none;">SE</td> </tr> </table>										JE	AE	EE	SE
JE	AE	EE	SE										
FLOW DIAGRAM FOR PROPOSED LIS BRANG DHARAMPUR BLOCK MANDI DISTRICT													
PURPOSE: FOR TENDER ONLY DO NOT SCALE													
Proprietary Notice and Version Control This document contains confidential information for use only by the Client; for the Project under consideration, which is provided for the sole purpose of permitting the recipient to evaluate the information submitted herewith, in consideration of receipt of this document, unless agreed to in contrary in the Contract; the recipient agrees to maintain such information in confidence and to not reproduce or otherwise disclose this information to any person outside the recipient's organization; except that there is no obligation to maintain the confidentiality of any information which was known to the recipient prior to receipt of such information from Tata Consulting Engineers Limited, or becomes publicly known through no fault of recipient, or Tata Consulting Engineers Limited, or is received without obligation of confidentiality from a third party owing no obligation of confidentiality to Tata Consulting Engineers Limited. All information given under this version over rules all and any kind of offers, assumptions, alterations and contracts submitted verbally (and subsequently communicated in writing) or in writing or otherwise given under any and all previous versions/s.													
TATA CONSULTING ENGINEERS LIMITED MUMBAI													
SCALE : NTS				DWG NO. TCE.12503A-CV-3082-FD-32184				ISSUE P1					
FILE NAME 12503A-CV-32184-Rev-P1													
DC & DISC: DEL-CV													

P1	SIGN.	SM	MJ	DVB						MK	DK	20-07-2022
	REVISIONS	AS PER CLIENT COMMENTS										
P0	SIGN.	SM	MJ	DVB						MK	DK	01-06-2022
	REVISIONS											
ISSUE	DRN	DSN	CHD	CV	EL	IC	ME		PE/PM	APPD	DATE	(dd-mm-yyyy)
ALL CELLS ABOVE 'ME' ARE TO BE CLEARED												

LEGEND:

EXISTING COMPONENT 

SOURCE 

PUMP 

NOTE:

1. ALL PIPE DIAMETERS ARE IN MILLIMETER.
2. RL MAY VARY AS PER ACTUAL ROUTE SURVEY.

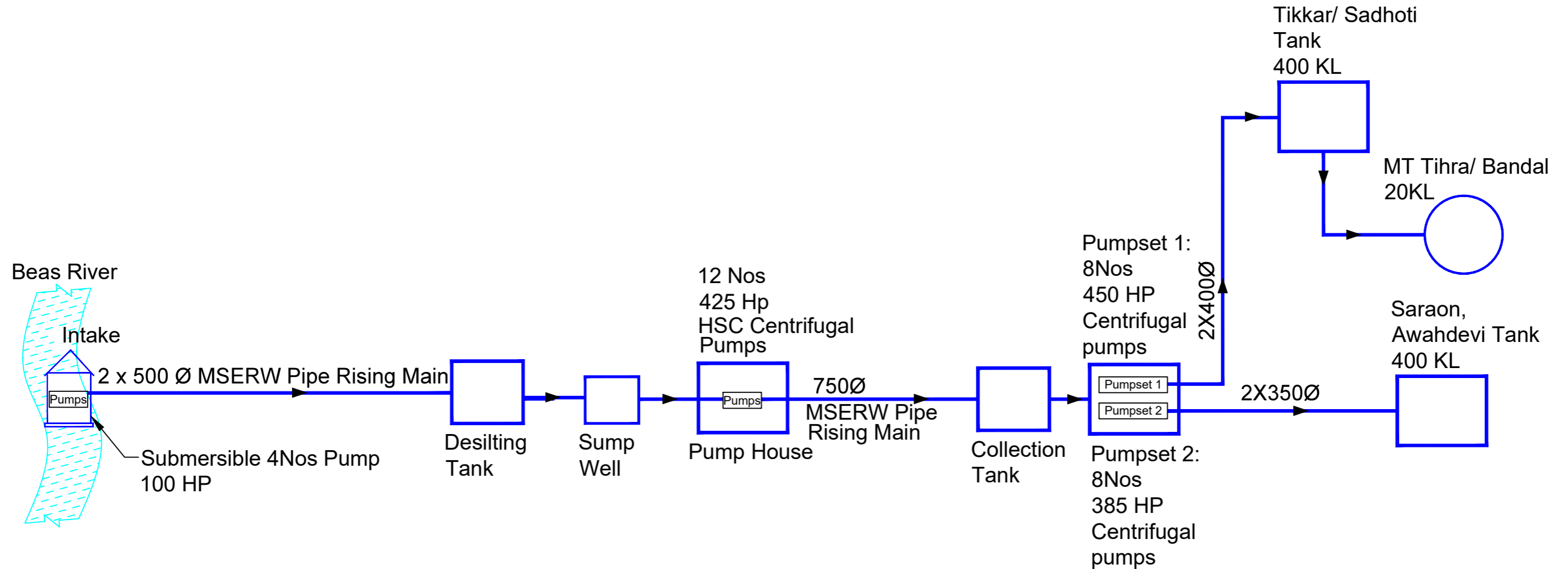

FLOW DIAGRAM – EXISTING LIS TIHRA

P1	SIGN.																	
	INITIALS	SM	MJ	DVB					MK	DK	20-07-2022	'P' (PRELIMINARY) ISSUES ARE NOT TO BE USED FOR CONSTRUCTION / FABRICATION BUT ARE ISSUED FOR LIMITED PURPOSES ONLY AS INDICATED IN THE SMALL BLOCK ABOVE THIS BLOCK. CONSTRUCTION / FABRICATION WORK IS PERMITTED ON 'R' (RELEASED) ISSUES ONLY. INFORMATION CONTAINED WITHIN 'HOLD' IS NOT RELEASED FOR CONSTRUCTION / FABRICATION. FIELD MUST GET DESIGN OFFICE TO CLEAR 'HOLDS' IN TIME BEFORE PROCEEDING WITH ANY CONSTRUCTION/ FABRICATION WORK RELATED TO 'HOLDS'.						
REVISIONS	AS PER CLIENT COMMENTS																	
DATE	11-06-2022																	
PO	SIGN.																	
	INITIALS	SM	MJ	DVB					MK	DK	21-06-2022							
REVISIONS																		
ISSUE		DRN	DSN	CHD	CV	EL	IC	ME		PE/PM	APPD	DATE						
					CLEARED							(dd-mm-yyyy)						

SIGN. OF CLIENT:–			
JE	AE	EE	SE
PURPOSE: FOR TENDER ONLY			
DO NOT SCALE			
<small>Proprietary Notice and Version Control This document contains confidential information for use only by the Client ; for the Project under consideration, which is provided for the sole purpose of permitting the recipient to evaluate the information submitted herewith, in consideration of receipt of this document unless agreed to in contrary in the Contract; the recipient agrees to maintain such information in confidence and to not reproduce or otherwise disclose this information to any person outside the recipient's organization; except that there is no obligation to maintain the confidentiality of any information which was known to the recipient prior to receipt of such information from Tata Consulting Engineers Limited, or becomes publicly known through no fault of recipient, or Tata Consulting Engineers Limited, or is received without obligation of confidentiality from a third party owing no obligation of confidentiality to Tata Consulting Engineers Limited. All information given under this version over rides all and any kind of offers, reservations, submissions and contracts submitted verbally (and subsequently communicated in writing) or in writing or otherwise given under any and all previous version/s.</small>			
FILE NAME 12503A–CV–32185–Rev–P1			

 DETAILED DESIGN CONSULTANCY, HP–SHIVA (PACKAGE CS09)
 IRRIGATION, HORTICULTURE, ORCHARDS AND VALUE CHAIN DEVELOPMENT

FLOW DIAGRAM FOR EXISTING LIS TIHRA
 DHARAMPUR BLOCK MANDI DISTRICT



SCALE : NTS	DWG NO. TCE.12503A–CV–3082–FD–32185	ISSUE P1
DC & DISC: DEL–CV		TCE FORM NO. 093 R1

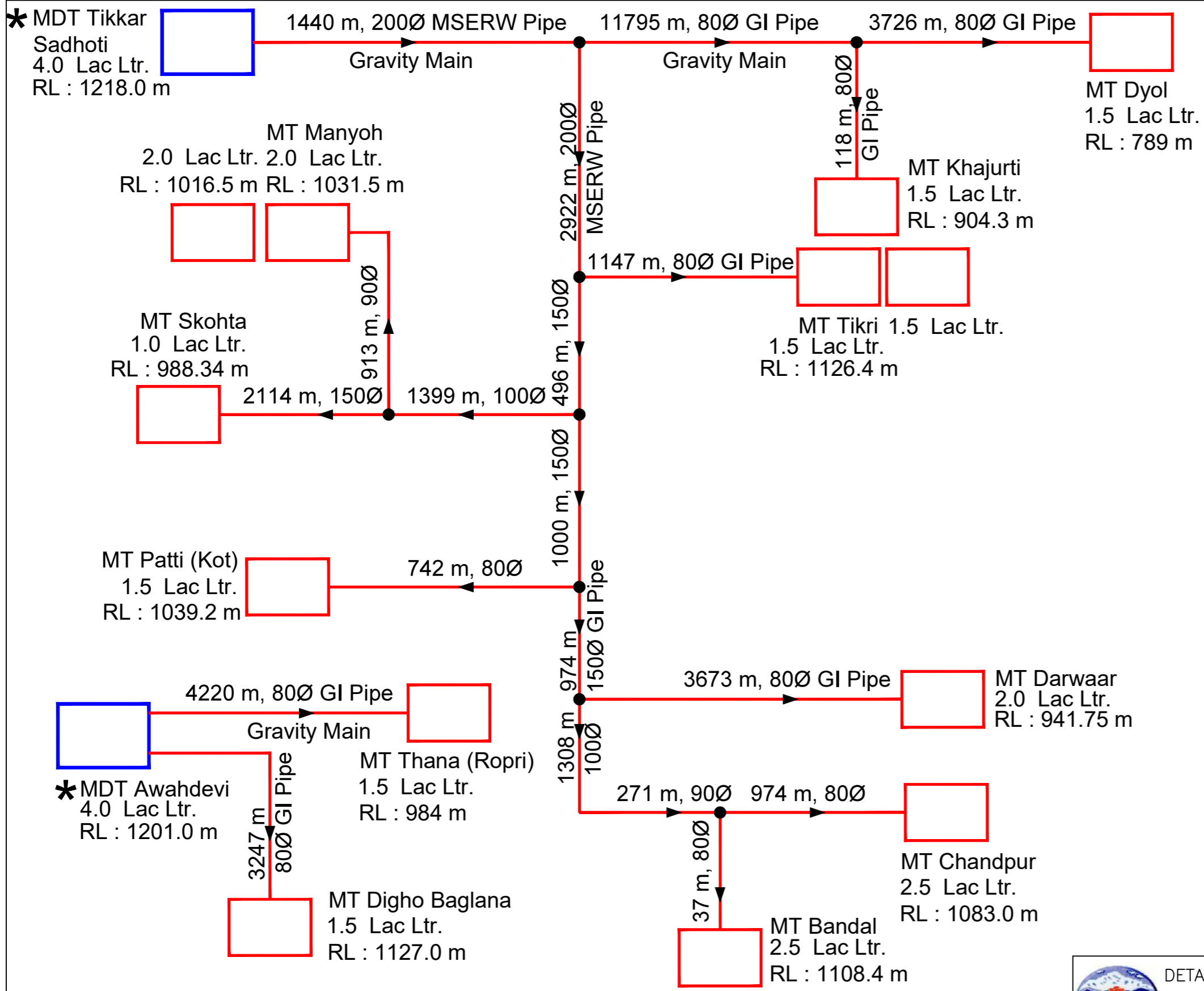

LEGEND:

- EXISTING COMPONENT →
- PROPOSED COMPONENT →

NOTE:

1. ALL PIPE DIAMETERS ARE IN MILLIMETER.
2. RL MAY VARY AS PER ACTUAL ROUTE SURVEY.

* REFER DRAWING NO. TCE.12503A-CV-3082-FD-32185 FOR EXISTING LIS DETAILS.

**FLOW DIAGRAM – PROPOSED LIS TIHRA
(NEW SCHEME – 102.15 Ha)**



DETAILED DESIGN CONSULTANCY, HP-SHIVA (PACKAGE CS09)
IRRIGATION, HORTICULTURE, ORCHARDS AND VALUE CHAIN DEVELOPMENT

FLOW DIAGRAM FOR PROPOSED LIS TIHRA
DHARAMPUR BLOCK MANDI DISTRICT

SIGN. OF CLIENT:-

JE	AE	EE	SE

PURPOSE: FOR TENDER ONLY
DO NOT SCALE

Proprietary Notice and Version Control This document contains confidential information for use only by the Client; for the Project under consideration, which is provided for the sole purpose of permitting the recipient to evaluate the information submitted herewith. In consideration of receipt of this document unless agreed to in contrary in the Contract, the recipient agrees to maintain such information in confidence and to not reproduce or otherwise disclose this information to any person outside the recipient's organization except that there is no obligation to maintain the confidentiality of any information which was known to the recipient prior to receipt of such information from Tata Consulting Engineers Limited, or becomes publicly known through no fault of recipient, or Tata Consulting Engineers Limited, or is received without obligation of confidentiality from a third party using no obligation of confidentiality to Tata Consulting Engineers Limited. All information given under this version over rides all and any kind of offers, reservations, submissions and contracts submitted verbally (and subsequently communicated in writing) or in writing or otherwise given under any and all previous version/s.

FILE NAME 12503A-CV-32186-Rev-P1







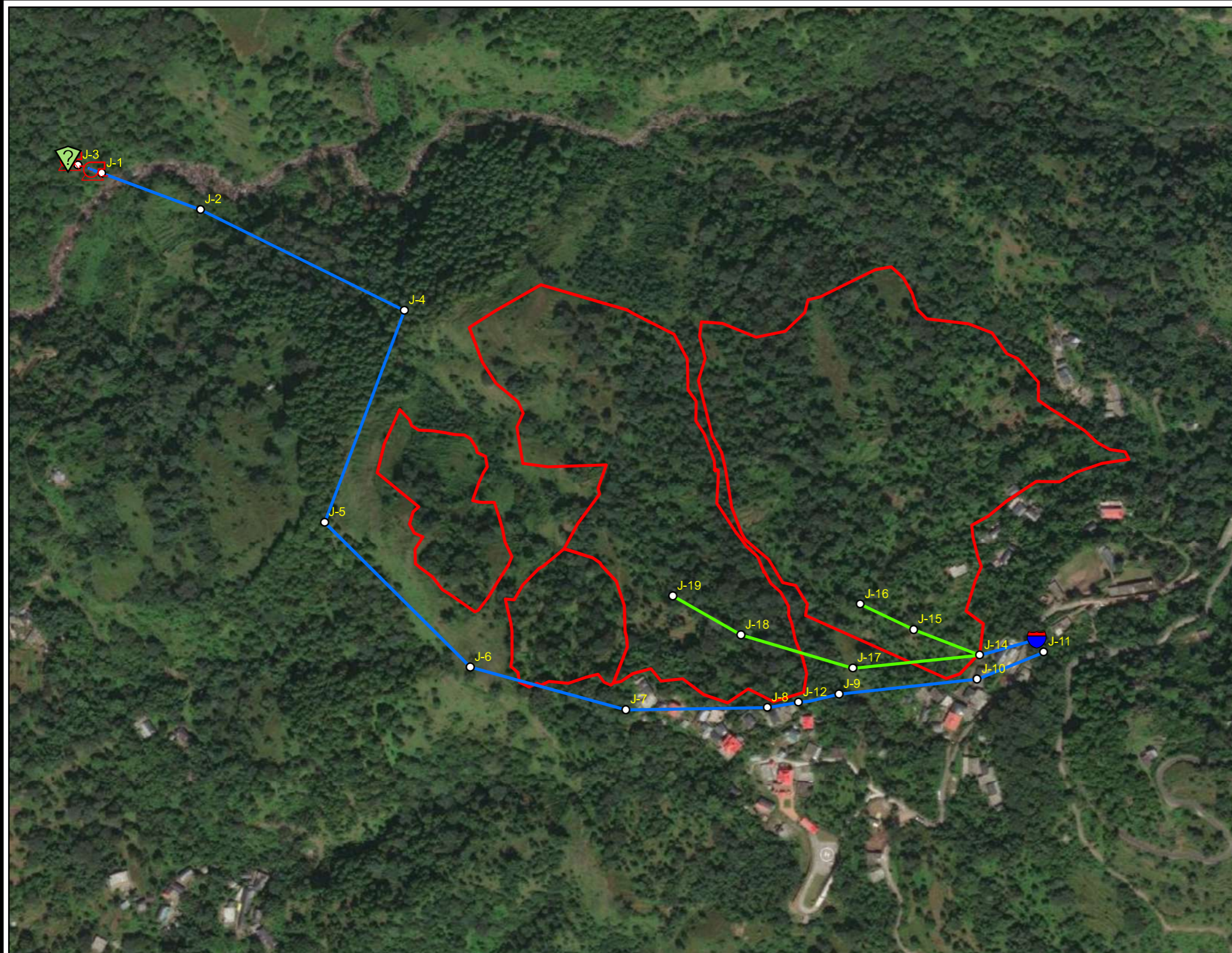
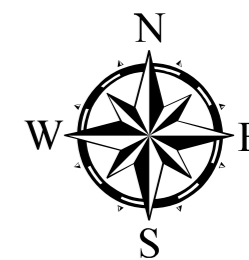

TATA CONSULTING ENGINEERS LIMITED
MUMBAI

P1	SIGN.																
	INITIALS	SM	MJ	DVB						MK	DK	20-07-2022	<small>'P' (PRELIMINARY) ISSUES ARE NOT TO BE USED FOR CONSTRUCTION / FABRICATION BUT ARE ISSUED FOR LIMITED PURPOSES ONLY AS INDICATED IN THE SMALL BLOCK ABOVE THIS BLOCK.</small> <small>CONSTRUCTION / FABRICATION WORK IS PERMITTED ON 'R' (RELEASED) ISSUES ONLY.</small> <small>INFORMATION CONTAINED WITHIN 'HOLD' IS NOT RELEASED FOR CONSTRUCTION / FABRICATION. FIELD MUST GET DESIGN OFFICE TO CLEAR 'HOLDS' IN TIME BEFORE PROCEEDING WITH ANY CONSTRUCTION/ FABRICATION WORK RELATED TO 'HOLDS'.</small>				
REVISIONS	AS PER CLIENT COMMENTS																
P0	SIGN.																
	INITIALS	SM	MJ	DVB						MK	DK	01-06-2022	<small>CONSTRUCTION / FABRICATION WORK IS PERMITTED ON 'R' (RELEASED) ISSUES ONLY.</small> <small>INFORMATION CONTAINED WITHIN 'HOLD' IS NOT RELEASED FOR CONSTRUCTION / FABRICATION. FIELD MUST GET DESIGN OFFICE TO CLEAR 'HOLDS' IN TIME BEFORE PROCEEDING WITH ANY CONSTRUCTION/ FABRICATION WORK RELATED TO 'HOLDS'.</small>				
REVISIONS																	
ISSUE	DRN	DSN	CHD	CV	EL	IC	ME			PE/PM	APPD	DATE (dd-mm-yyyy)					
													CLEARED				



Source: Esri, Maxar

Legend

-  Source
-  MDT
-  Pump
-  Junction
-  Rising Main 100mm Dia GI Pipe
-  Gravity Main 80mm Dia GI Pipe
-  GOLWAN Cluster

SIGN. OF CLIENT:-

JE	AE	EE	SE
----	----	----	----



DETAILED DESIGN CONSULTANCY, HP-SHIVA (PACKAGE CS09)

IRRIGATION, HORTICULTURE, ORCHARDS AND VALUE CHAIN DEVELOPMENT

	SIGN.									
	INITIALS									
	REVISIONS									
P0	SIGN.									
	INITIALS	GKJ	MXL	DVB		MK	DK	14-06-2022		
	REVISIONS									
ISSUE	DRN	DSN	CHD	CV	EL	IC	ME	PE/PM	APPD.	DATE
				CLEARED						

'P' (PRELIMINARY) ISSUES ARE NOT TO BE USED FOR CONSTRUCTION / FABRICATION BUT ARE ISSUED FOR LIMITED PURPOSES ONLY AS INDICATED IN THE SMALL BLOCK ABOVE THIS BLOCK.

CONSTRUCTION / FABRICATION WORK IS PERMITTED ON 'R' (RELEASED) ISSUES ONLY.

INFORMATION CONTAINED WITHIN 'HOLD' IS NOT RELEASED FOR CONSTRUCTION / FABRICATION. FIELD MUST GET DESIGN OFFICE TO CLEAR 'HOLDS' IN TIME BEFORE PROCEEDING WITH ANY CONSTRUCTION/FABRICATION WORK RELATED TO 'HOLDS'.

PURPOSE: FOR TENDER ONLY

Proprietary Notice and Version Control This document contains confidential information for use only by the "Client"; for the Project under consideration, which is provided for the sole purpose of permitting the recipient to evaluate the information submitted here with in consideration of receipt of this document; unless agreed to in contrary in the Contract, the recipient agrees to maintain such information in confidence and to not reproduce or otherwise disclose this information to any person outside the recipient's organisation; except that there is no obligation to maintain the confidentiality of any information which was known to the recipient prior to receipt of such information from Tata Consulting Engineers Limited, or becomes publicly known through no fault of recipient, or Tata Consulting Engineers Limited, or is received without obligation of confidentiality from a third party owing no obligation of confidentiality to Tata Consulting Engineers Limited. All information given under this version over rides all and any kind of offers, assumptions, deliverables and contracts submitted verbally (and subsequently communicated in writing) or in writing or otherwise given under any and all previous version/s.

File Name: 12503A-CV-32201-Rev-P0

TITLE:-
NETWORK DRAWING FOR LIS GOLWAN CHAUNTARA BLOCK, MANDI DISTRICT.







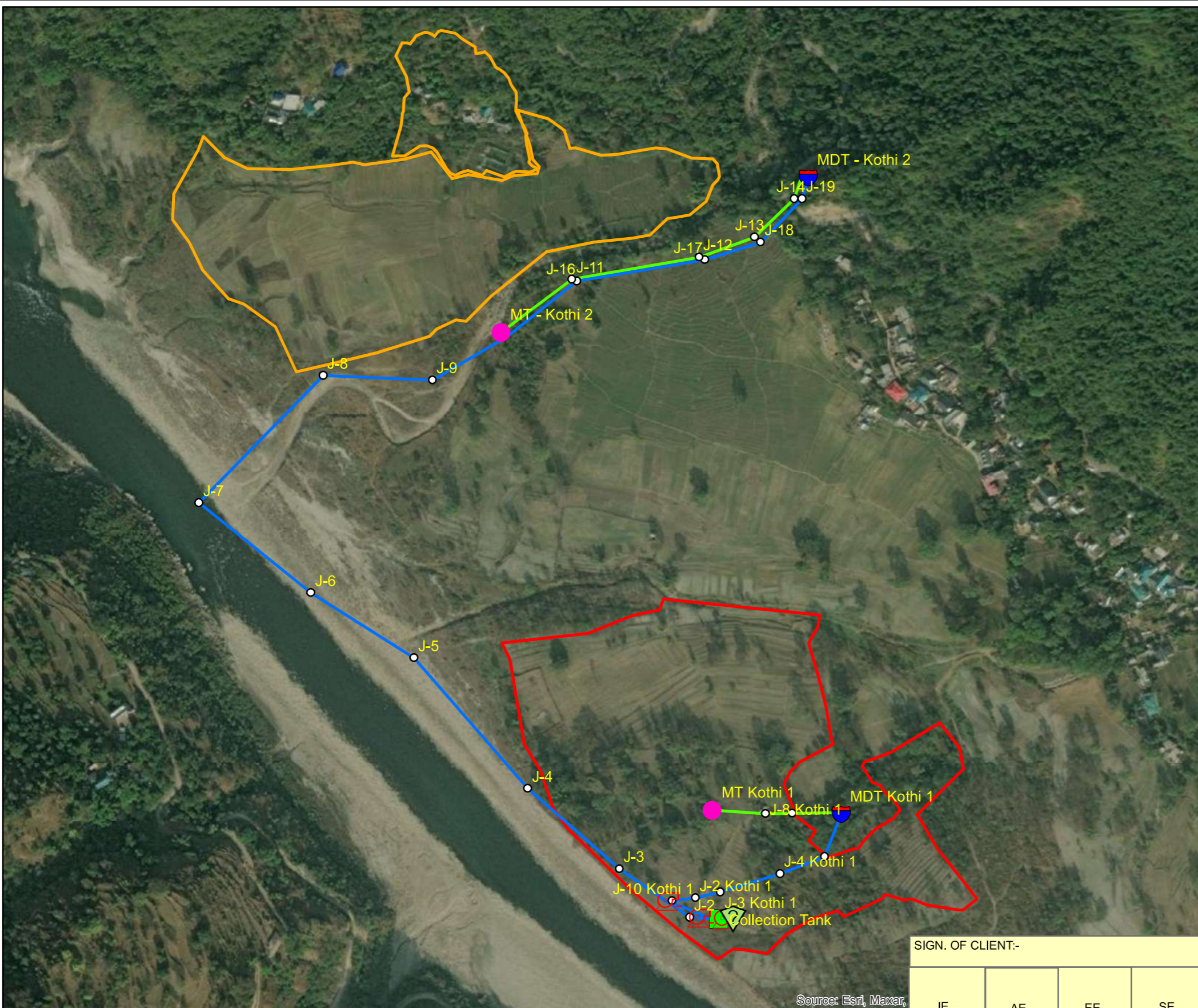





TATACONSULTING ENGINEERS LIMITED. MUMBAI

SCALE:- 1:5,000	DWG. No:- TCE.12503A-CV-3082-WS-32201	ISSUE:- P0
DL.CEN.:- DEL-CV		



Legend

-  Source
-  Pump
-  Junction
-  MDT
-  MT
-  Tank
-  Rising Main 80mm Dia GI Pipe
-  Gravity Main 80mm Dia GI Pipe
-  KOTHI-1
-  KOTHI_2

SIGN. OF CLIENT:-

JE	AE	EE	SE
----	----	----	----



DETAILED DESIGN CONSULTANCY, HP-SHIVA (PACKAGE CS09)

IRRIGATION, HORTICULTURE, ORCHARDS AND VALUE CHAIN DEVELOPMENT

PURPOSE: FOR TENDER ONLY

TITLE:- NETWORK DRAWING FOR LIS FROM TW-1 (KOTHI-1 & 2 CLUSTER) CHAUNTARA BLOCK, MANDI DISTRICT.

Proprietary Notice and Version Control This document contains confidential information for use only by the "Client"; for the Project under consideration, which is provided for the sole purpose of permitting the recipient to evaluate the information submitted here with in consideration of receipt of this document; unless agreed to in contrary in the Contract; the recipient agrees to maintain such information in confidence and to not reproduce or otherwise disclose this information to any person outside the recipient's organisation; except that there is no obligation to maintain the confidentiality of any information which was known to the recipient prior to receipt of such information from Tata Consulting Engineers Limited, or becomes publicly known through no fault of recipient, or Tata Consulting Engineers Limited, or is received without obligation of confidentiality from a third party owing no obligation of confidentiality to Tata Consulting Engineers Limited. All information given under this version over rides all and any kind of offers, assumptions, deliverables and contracts submitted verbally (and subsequently communicated in writing) or in writing or otherwise given under any and all previous version/s.

File Name: 12503A-CV-31202-Rev-P1



TATACONSULTING ENGINEERS LIMITED. MUMBAI

SCALE:- 1:5,000	DWG. No:- TCE.12503A-CV-3082-WS-31202	ISSUE:- P1
DL.CEN.:- DEL-CV		

P1	SIGN.												
	INITIALS	GKJ	MXL	DVB			MK	DK	22-07-2022				
REVISIONS	As per Client Comments												
P0	SIGN.												
	INITIALS	GKJ	MXL	DVB			MK	DK	14-06-2022				
REVISIONS													
ISSUE	DRN	DSN	CHD	CV	EL	IC	ME			PE/PM	APPD.	DATE	
				CLEARED									

'P' (PRELIMINARY) ISSUES ARE NOT TO BE USED FOR CONSTRUCTION / FABRICATION BUT ARE ISSUED FOR LIMITED PURPOSES ONLY AS INDICATED IN THE SMALL BLOCK ABOVE THIS BLOCK.

CONSTRUCTION / FABRICATION WORK IS PERMITTED ON 'R' (RELEASED) ISSUES ONLY.

INFORMATION CONTAINED WITHIN 'HOLD' IS NOT RELEASED FOR CONSTRUCTION / FABRICATION. FIELD MUST GET DESIGN OFFICE TO CLEAR 'HOLDS' IN TIME BEFORE PROCEEDING WITH ANY CONSTRUCTION/FABRICATION WORK RELATED TO 'HOLDS'.

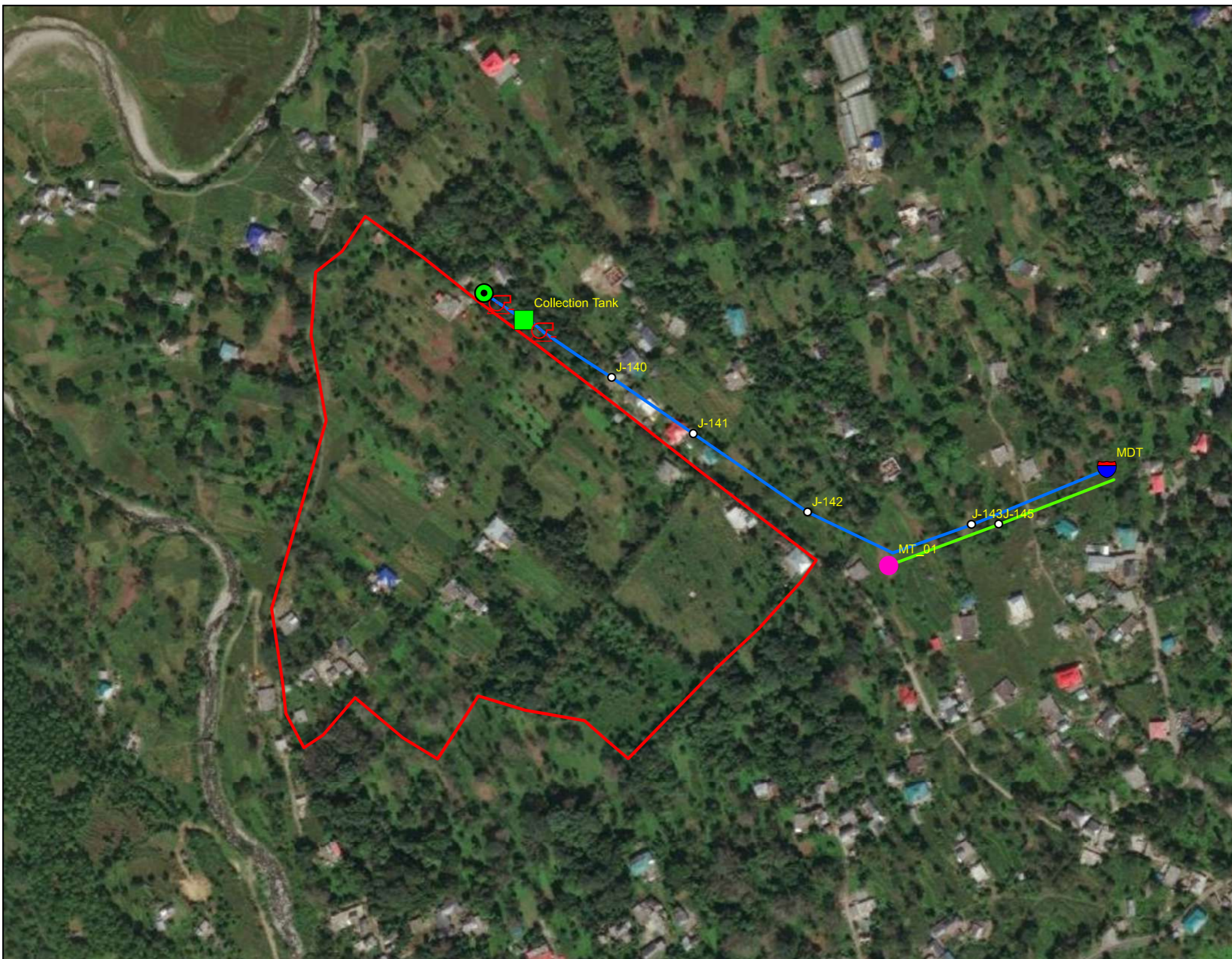
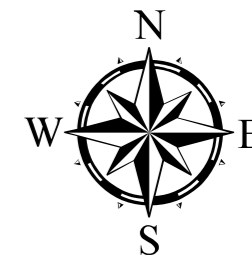

Source: Esri, Maxar

Legend

- Tube Well
- Pump
- MDT
- MT
- Tank
- Junction
- Rising Main 80mm Dia GI Pipe
- Gravity Main 80mm Dia GI Pipe
- DEHLLU

SIGN. OF CLIENT:-

JE	AE	EE	SE
----	----	----	----

DETAILED DESIGN CONSULTANCY, HP-SHIVA (PACKAGE CS09)

IRRIGATION, HORTICULTURE, ORCHARDS AND VALUE CHAIN DEVELOPMENT

SIGN.									14-06-2022		
	INITIALS										
REVISIONS											
SIGN.									14-06-2022		
	INITIALS	GKJ	MXL	DVB		MK	DK				
REVISIONS											
ISSUE	DRN	DSN	CHD	CV	EL	IC	ME		PE/PM	APPD.	DATE
				CLEARED							

'P' (PRELIMINARY) ISSUES ARE NOT TO BE USED FOR CONSTRUCTION / FABRICATION BUT ARE ISSUED FOR LIMITED PURPOSES ONLY AS INDICATED IN THE SMALL BLOCK ABOVE THIS BLOCK.

CONSTRUCTION / FABRICATION WORK IS PERMITTED ON 'R' (RELEASED) ISSUES ONLY.

INFORMATION CONTAINED WITHIN 'HOLD' IS NOT RELEASED FOR CONSTRUCTION / FABRICATION. FIELD MUST GET DESIGN OFFICE TO CLEAR 'HOLDS' IN TIME BEFORE PROCEEDING WITH ANY CONSTRUCTION/FABRICATION WORK RELATED TO 'HOLDS'.

PURPOSE: FOR TENDER ONLY

Proprietary Notice and Version Control This document contains confidential information for use only by the "Client"; for the Project under consideration, which is provided for the sole purpose of permitting the recipient to evaluate the information submitted here with in consideration of receipt of this document; unless agreed to in contrary in the Contract, the recipient agrees to maintain such information in confidence and to not reproduce or otherwise disclose this information to any person outside the recipient's organisation; except that there is no obligation to maintain the confidentiality of any information which was known to the recipient prior to receipt of such information from Tata Consulting Engineers Limited, or becomes publicly known through no fault of recipient, or Tata Consulting Engineers Limited, or is received without obligation of confidentiality from a third party owing no obligation of confidentiality to Tata Consulting Engineers Limited. All information given under this version over rides all and any kind of offers, assumptions, deliverables and contracts submitted verbally (and subsequently communicated in writing) or in writing or otherwise given under any and all previous version/s.

File Name: 12503A-CV-32204-Rev-P0

TITLE:- **NETWORK DRAWING FOR LIS DHELU (DHOG) CHAUNTARA BLOCK, MANDI DISTRICT.**

TATACONSULTING ENGINEERS LIMITED. MUMBAI

SCALE:- 1:4,000	DWG. No:- TCE.12503A-CV-3082-WS-32204	ISSUE:- P0
DL.CEN:- DEL-CV		

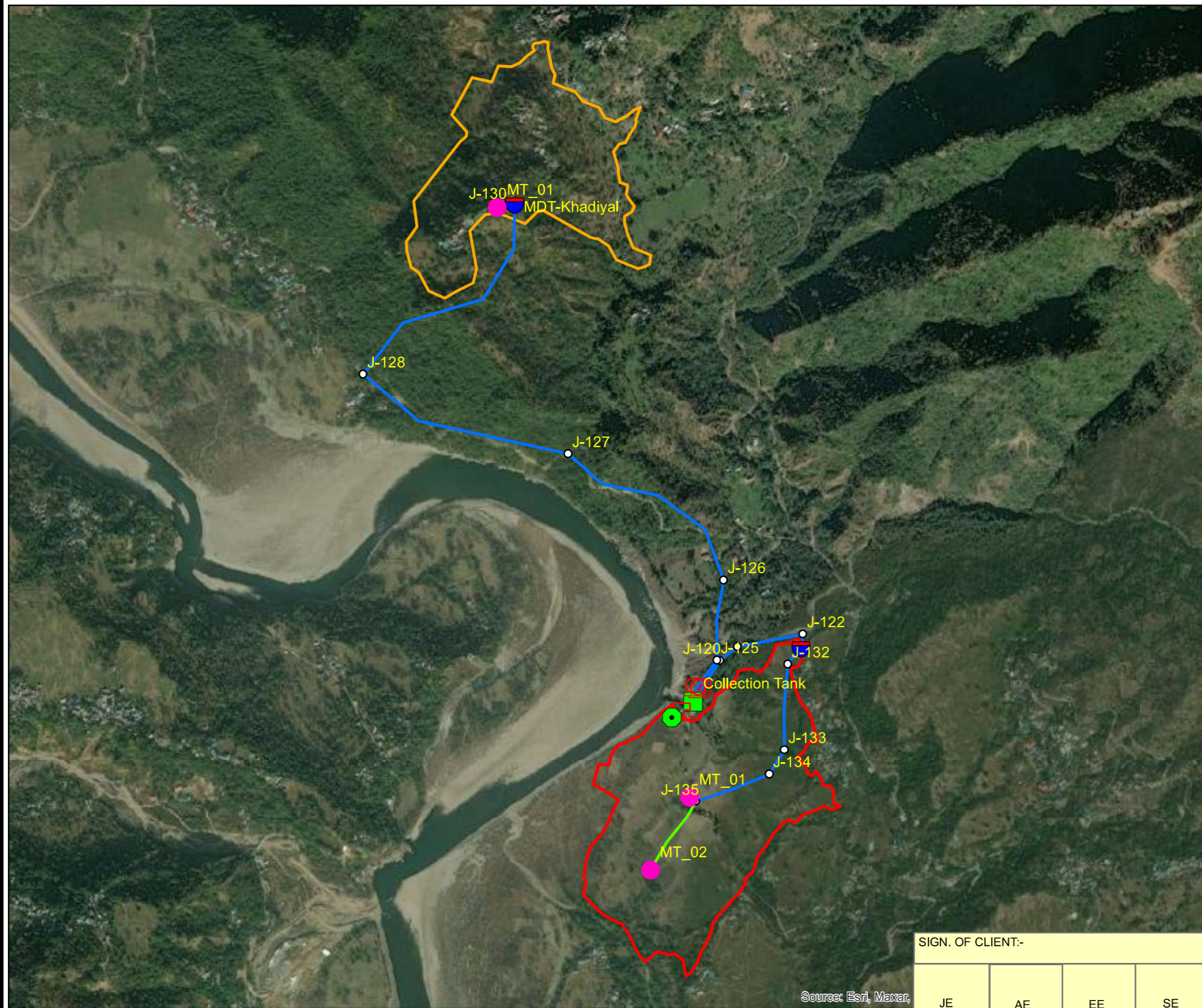
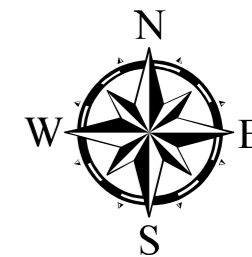

- Tube Well
- Pump
- Junction
- MDT
- MT
- Tank
- Gravity Main 80mm Dia GI Pipe
- Rising Main 100mm Dia GI Pipe
- Rising Main 125mm Dia GI Pipe
- Rising Main 150mm Dia GI Pipe
- DOL
- KHADIYAR

SIGN. OF CLIENT:-

JE	AE	EE	SE
----	----	----	----



**DETAILED DESIGN CONSULTANCY, HP-SHIVA
(PACKAGE CS09)**

IRRIGATION, HORTICULTURE, ORCHARDS AND VALUE CHAIN DEVELOPMENT

PURPOSE: FOR TENDER ONLY

TITLE:- **NETWORK DRAWING FOR LIS FROM TW-2
(KHADIYAL CLUSTER & DOL CLUSTER)
CHAUNTARA BLOCK, MANDI DISTRICT.**



**TATACONSULTING ENGINEERS LIMITED.
MUMBAI**

SCALE:- 1:14,000

DWG. No:-

TCE.12503A-CV-3082-WS-32205

ISSUE:-

P1

P1	SIGN.												
	INITIALS	GKJ	MXL	DVB		MK	DK	22-07-2022					
	REVISIONS	As per Client Comments											
P0	SIGN.												
	INITIALS	GKJ	MXL	DVB		MK	DK	14-06-2022					
	REVISIONS												
ISSUE		DRN	DSN	CHD	CV	EL	IC	ME			PE/PM	APPD.	DATE
					CLEARED								

'P' (PRELIMINARY) ISSUES ARE NOT TO BE USED FOR CONSTRUCTION / FABRICATION BUT ARE ISSUED FOR LIMITED PURPOSES ONLY AS INDICATED IN THE SMALL BLOCK ABOVE THIS BLOCK.

CONSTRUCTION / FABRICATION WORK IS PERMITTED ON 'R' (RELEASED) ISSUES ONLY.

INFORMATION CONTAINED WITHIN 'HOLD' IS NOT RELEASED FOR CONSTRUCTION / FABRICATION. FIELD MUST GET DESIGN OFFICE TO CLEAR 'HOLDS' IN TIME BEFORE PROCEEDING WITH ANY CONSTRUCTION/FABRICATION WORK RELATED TO 'HOLDS'.





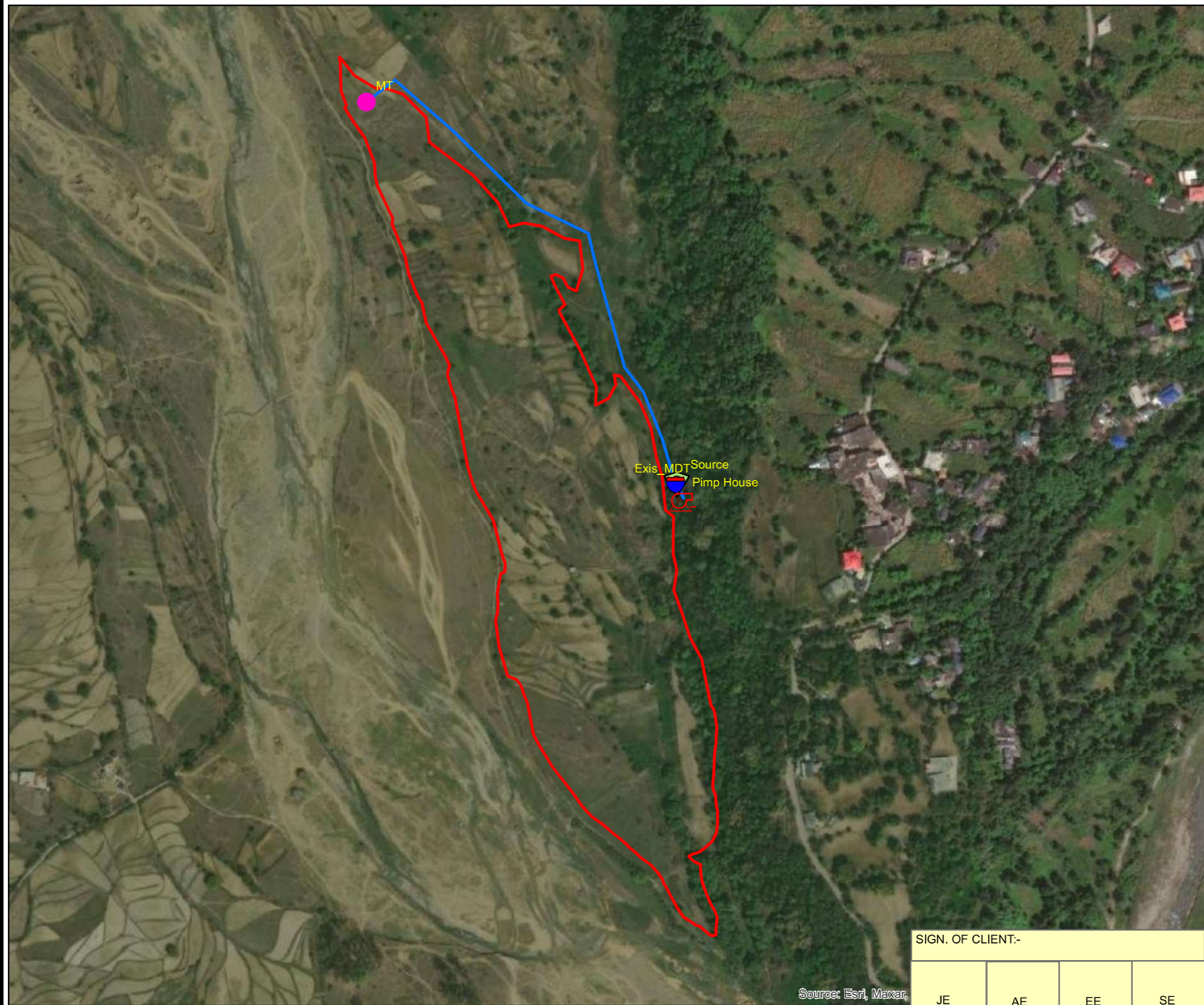

Proprietary Notice and Version Control This document contains confidential information for use only by the "Client"; for the Project under consideration, which is provided for the sole purpose of permitting the recipient to evaluate the information submitted here with in consideration of receipt of this document; unless agreed to in contrary in the Contract, the recipient agrees to maintain such information in confidence and to not reproduce or otherwise disclose this information to any person outside the recipient's organisation; except that there is no obligation to maintain the confidentiality of any information which was known to the recipient prior to receipt of such information from Tata Consulting Engineers Limited, or becomes publicly known through no fault of recipient, or Tata Consulting Engineers Limited, or is received without obligation of confidentiality from a third party owing no obligation of confidentiality to Tata Consulting Engineers Limited. All information given under this version over rides all and any kind of offers, assumptions, deliverables and contracts submitted verbally (and subsequently communicated in writing) or in writing or otherwise given under any and all previous version/s.

File Name: 12503A-CV-32205-Rev-P1

DL.CEN:- DEL-CV



Legend

-  Source
-  MT
-  Exis_MDT
-  Pimp House
-  Rising Main
-  Sulpur Bahi Cluster

Source: Esri, Maxar

SIGN. OF CLIENT:-

JE	AE	EE	SE
----	----	----	----



**DETAILED DESIGN CONSULTANCY, HP-SHIVA
(PACKAGE CS09)**

IRRIGATION, HORTICULTURE, ORCHARDS AND VALUE CHAIN DEVELOPMENT

SIGN.									PE/PM	APPD.	DATE
	INITIALS										
REVISIONS											
SIGN.									NS	NS	02-06-2022
	INITIALS	GKJ	MP	DVB							
REVISIONS											
ISSUE	DRN	DSN	CHD	CV	EL	IC	ME				
	CLEARED										

'P' (PRELIMINARY) ISSUES ARE NOT TO BE USED FOR CONSTRUCTION / FABRICATION BUT ARE ISSUED FOR LIMITED PURPOSES ONLY AS INDICATED IN THE SMALL BLOCK ABOVE THIS BLOCK.

CONSTRUCTION / FABRICATION WORK IS PERMITTED ON 'R' (RELEASED) ISSUES ONLY.

INFORMATION CONTAINED WITHIN 'HOLD' IS NOT RELEASED FOR CONSTRUCTION / FABRICATION. FIELD MUST GET DESIGN OFFICE TO CLEAR 'HOLDS' IN TIME BEFORE PROCEEDING WITH ANY CONSTRUCTION/FABRICATION WORK RELATED TO 'HOLDS'.

PURPOSE: FOR TENDER ONLY

Proprietary Notice and Version Control This document contains confidential information for use only by the "Client"; for the Project under consideration, which is provided for the sole purpose of permitting the recipient to evaluate the information submitted here with. In consideration of receipt of this document, unless agreed to in contrary in the Contract, the recipient agrees to maintain such information in confidence and to not reproduce or otherwise disclose this information to any person outside the recipient's organisation; except that there is no obligation to maintain the confidentiality of any information which was known to the recipient prior to receipt of such information from Tata Consulting Engineers Limited, or becomes publicly known through no fault of recipient, or Tata Consulting Engineers Limited, or is received without obligation of confidentiality from a third party owing no obligation of confidentiality to Tata Consulting Engineers Limited. All information given under this version over rides all and any kind of offers, assumptions, deliverables and contracts submitted verbally (and subsequently communicated in writing) or in writing or otherwise given under any and all previous version/s.

File Name: 12503A-CV-32206-Rev-P0

TITLE:-
**NETWORK DRAWING FOR LIS SULPUR BAHI
(SULPUR CLUSTER)
GOPALPUR BLOCK, MANDI DISTRICT.**



**TATACONSULTING ENGINEERS LIMITED.
MUMBAI**

SCALE:- 1:4,000	DWG. No:-	ISSUE:-
DL.CEN:- DEL-CV	TCE.12503A-CV-3082-WS-32206	P0

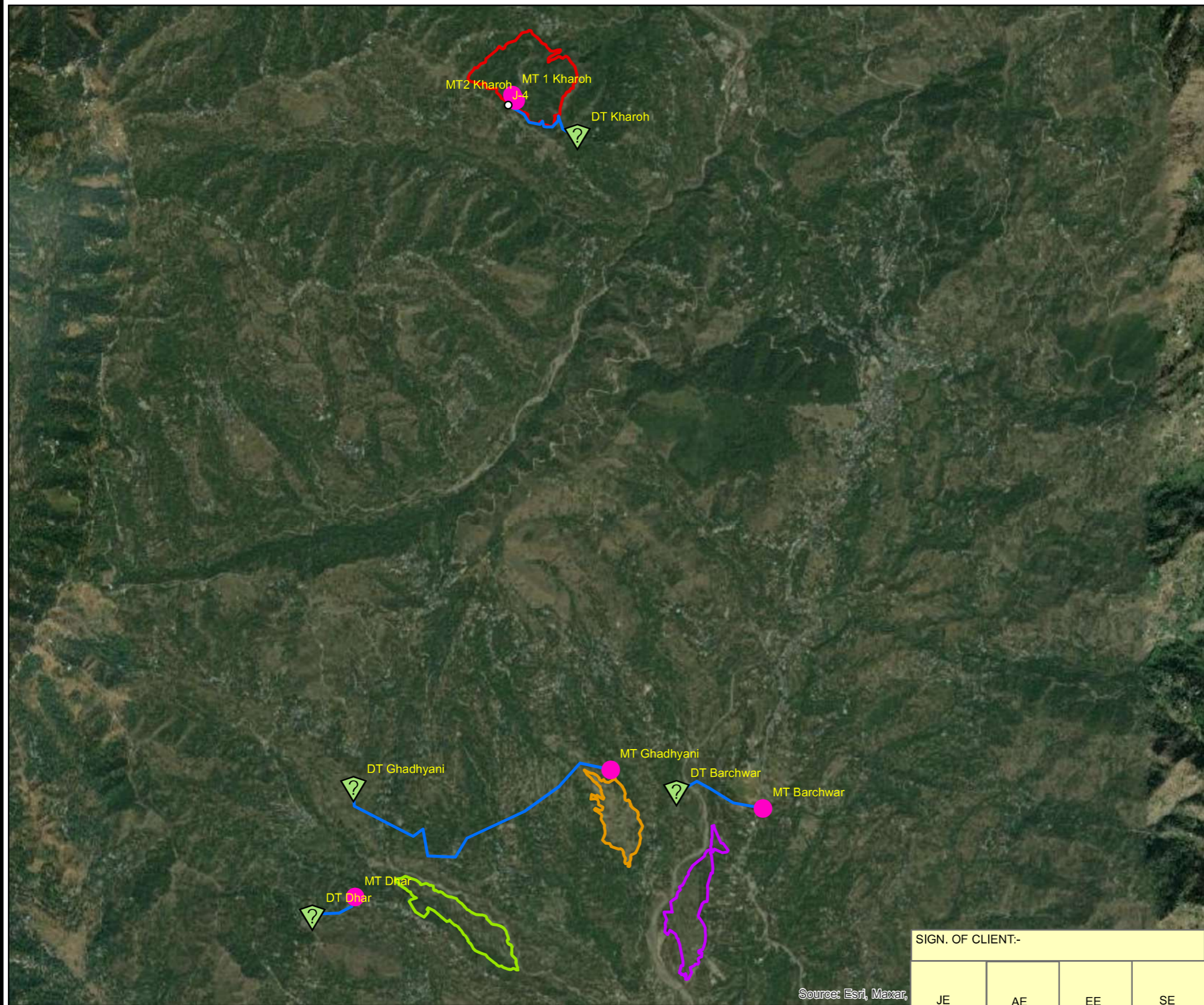

Legend

- reservoir
- MT
- Junction
- Rising Main
- BARCHWAR
- KHARHO
- GHADHYANI
- DHAR

Source: Esri, Maxar,

SIGN. OF CLIENT:-

JE	AE	EE	SE
----	----	----	----

 **DETAILED DESIGN CONSULTANCY, HP-SHIVA (PACKAGE CS09)**
IRRIGATION, HORTICULTURE, ORCHARDS AND VALUE CHAIN DEVELOPMENT

SIGN.												
	INITIALS											
REVISIONS												
SIGN.												
	INITIALS	GKJ	MXL	DVB				MK	DK	14-06-2022		
REVISIONS												
ISSUE	DRN	DSN	CHD	CV	EL	IC	ME			PE/PM	APPD.	DATE
	CLEARED											

'P' (PRELIMINARY) ISSUES ARE NOT TO BE USED FOR CONSTRUCTION / FABRICATION BUT ARE ISSUED FOR LIMITED PURPOSES ONLY AS INDICATED IN THE SMALL BLOCK ABOVE THIS BLOCK.

CONSTRUCTION / FABRICATION WORK IS PERMITTED ON 'R' (RELEASED) ISSUES ONLY.

INFORMATION CONTAINED WITHIN 'HOLD' IS NOT RELEASED FOR CONSTRUCTION / FABRICATION. FIELD MUST GET DESIGN OFFICE TO CLEAR 'HOLDS' IN TIME BEFORE PROCEEDING WITH ANY CONSTRUCTION/FABRICATION WORK RELATED TO 'HOLDS'.

PURPOSE: FOR TENDER ONLY

Proprietary Notice and Version Control This document contains confidential information for use only by the "Client"; for the Project under consideration, which is provided for the sole purpose of permitting the recipient to evaluate the information submitted here with in consideration of receipt of this document; unless agreed to in contrary in the Contract, the recipient agrees to maintain such information in confidence and to not reproduce or otherwise disclose this information to any person outside the recipient's organisation; except that there is no obligation to maintain the confidentiality of any information which was known to the recipient prior to receipt of such information from Tata Consulting Engineers Limited, or becomes publicly known through no fault of recipient, or Tata Consulting Engineers Limited, or is received without obligation of confidentiality from a third party owing no obligation of confidentiality to Tata Consulting Engineers Limited. All information given under this version over rides all and any kind of offers, assumptions, deliverables and contracts submitted verbally (and subsequently communicated in writing) or in writing or otherwise given under any and all previous version/s.

File Name: 12503A-CV-32207-Rev-P0

TITLE:- **NETWORK DRAWING FOR LIS BASANTPUR (DHAR, BARCHWAR, GHADHYANI, KHAROH) GOPALPUR BLOCK, MANDI DISTRICT.**



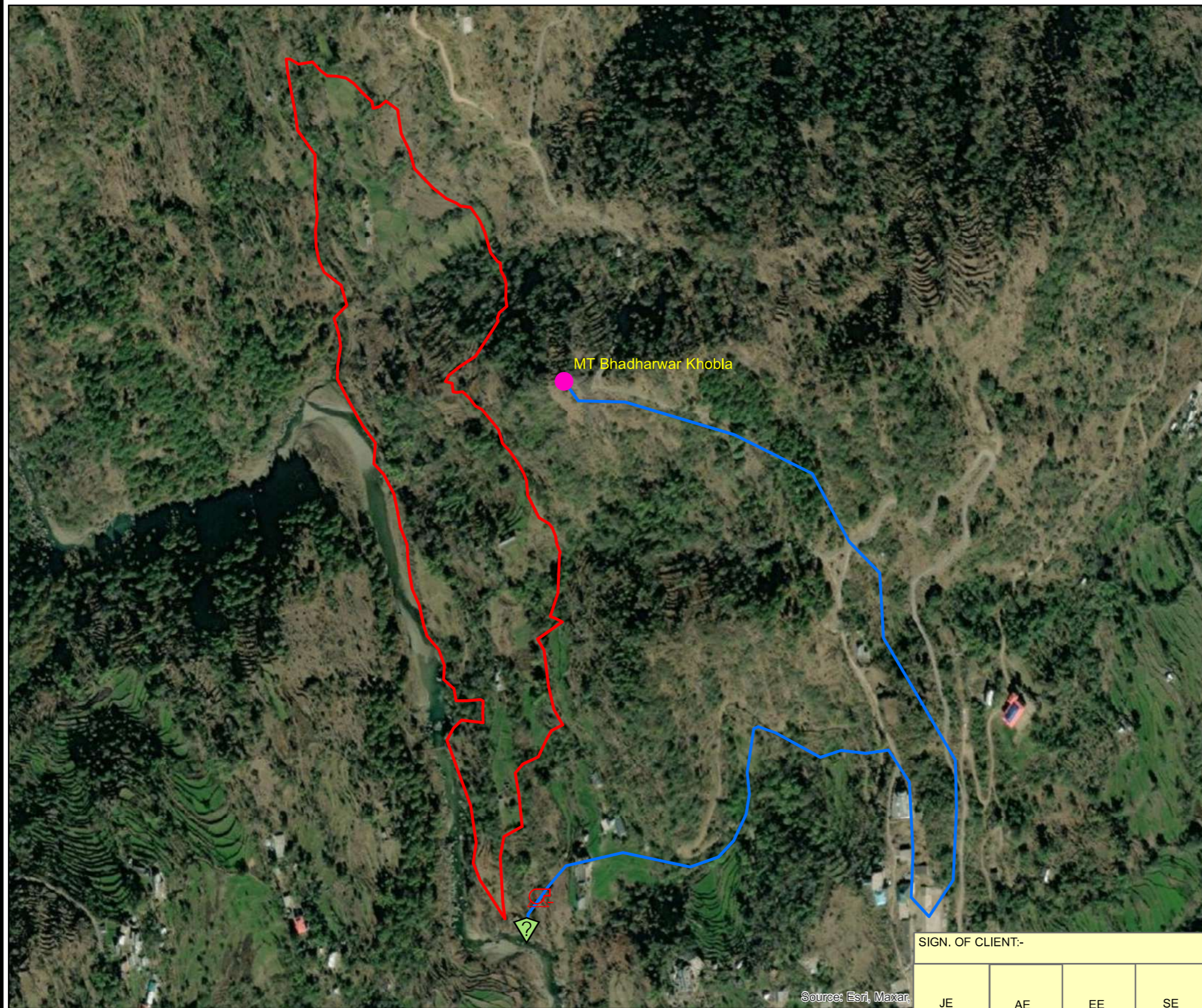
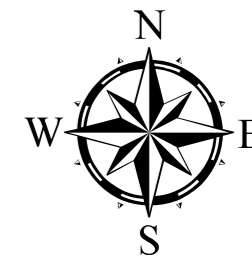

 **TATACONSULTING ENGINEERS LIMITED. MUMBAI**

SCALE:- 1:28,000	DWG. No:- TCE.12503A-CV-3082-WS-32207	ISSUE:- P0
DL.CEN:- DEL-CV		



Source: Esri, Maxar

Legend

-  Reservoir
-  Pump
-  Junction
-  Rising Main 80mm Dia GI Pipe
-  BHADARWAR Cluster

SIGN. OF CLIENT:-

JE AE EE SE

PURPOSE: FOR TENDER ONLY

Proprietary Notice and Version Control This document contains confidential information for use only by the "Client"; for the Project under consideration, which is provided for the sole purpose of permitting the recipient to evaluate the information submitted here with in consideration of receipt of this document; unless agreed to in contrary in the Contract, the recipient agrees to maintain such information in confidence and to not reproduce or otherwise disclose this information to any person outside the recipient's organisation; except that there is no obligation to maintain the confidentiality of any information which was known to the recipient prior to receipt of such information from Tata Consulting Engineers Limited, or becomes publicly known through no fault of recipient, or Tata Consulting Engineers Limited, or is received without obligation of confidentiality from a third party owing no obligation of confidentiality to Tata Consulting Engineers Limited. All information given under this version over rides all and any kind of offers, assumptions, deliverables and contracts submitted verbally (and subsequently communicated in writing) or in writing or otherwise given under any and all previous version/s.

File Name: 12503A-CV-32208-Rev-P1



DETAILED DESIGN CONSULTANCY, HP-SHIVA (PACKAGE CS09)

IRRIGATION, HORTICULTURE, ORCHARDS AND VALUE CHAIN DEVELOPMENT

TITLE:- **NETWORK DRAWING FOR LIS BHADHARWAR (BHUDROLI KHAD) GOPALPUR BLOCK, MANDI DISTRICT.**



TATACONSULTING ENGINEERS LIMITED. MUMBAI

SCALE:- 1:5,000

DWG. No:-

TCE.12503A-CV-3082-WS-32208

ISSUE:-

P1

P1	SIGN.																		
	INITIALS	GKJ	MXL	DVB						MK	DK	22-07-2022							
	REVISIONS	As per Client Comments																	
P0	SIGN.																		
	INITIALS	GKJ	MXL	DVB						MK	DK	14-06-2022							
	REVISIONS																		
ISSUE		DRN	DSN	CHD	CV	EL	IC	ME			PE/PM	APPD.	DATE						
					CLEARED														

'P' (PRELIMINARY) ISSUES ARE NOT TO BE USED FOR CONSTRUCTION / FABRICATION BUT ARE ISSUED FOR LIMITED PURPOSES ONLY AS INDICATED IN THE SMALL BLOCK ABOVE THIS BLOCK.

CONSTRUCTION / FABRICATION WORK IS PERMITTED ON 'R' (RELEASED) ISSUES ONLY.

INFORMATION CONTAINED WITHIN 'HOLD' IS NOT RELEASED FOR CONSTRUCTION / FABRICATION. FIELD MUST GET DESIGN OFFICE TO CLEAR 'HOLDS' IN TIME BEFORE PROCEEDING WITH ANY CONSTRUCTION/FABRICATION WORK RELATED TO 'HOLDS'.